

110 / 130 / 150   
MANUAL DE INSTALACIÓN

SISTEMA ZIP / GUÍA / CABLE / VARILLA  
MANIOBRA CARDAN / MOTOR (CHERUBINI)



ES / EN / FR / PT

**Mauré**

(R1)



05

ESPAÑOL

---

57

ENGLISH

---

109

FRANÇAIS

---

161

PORTUGUÊS

---



## INTRODUCCIÓN

Información preliminar  
Advertencia sobre el uso  
Responsabilidad  
Requisitos del usuario y del instalador

---

## INSTALACIÓN Y PUESTA EN MARCHA

Instalación  
Puesta en marcha  
Motorización y Automatismos  
Mantenimiento / Desmontaje y eliminación

---

## DIAGRAMA DE DESPIECE COMBINACIONES

---

## PROBLEMAS, CAUSAS Y SOLUCIONES

---

## INFORMACIÓN PRELIMINAR



### **Este manual no debe ser modificado.**

Está dirigido a aquellos que van a utilizar el sistema de caída vertical (a partir de ahora *toldo*), como el instalador, el mantenedor, el propietario o el usuario, y constituye el instrumento esencial para el correcto uso y mantenimiento del producto. Las instrucciones relativas a la manipulación, desembalaje, instalación y puesta en marcha, regulación y mantenimiento están dirigidos al instalador. Las instrucciones relativas a los modos correctos de uso y mantenimiento, así como la garantía, están dirigidas al propietario.

Este manual de uso es parte integrante del producto y esencial para la validez de la garantía. Consérvelo en su integridad y en un lugar fácilmente accesible, estando siempre a disposición del personal cualificado encargado de la instalación, mantenimiento o ajuste para permitir efectuar los registros necesarios.

### ADVERTENCIA SOBRE EL USO

- Lea atentamente las instrucciones del siguiente manual.
- Antes de la instalación, compruebe que el toldo se encuentra en perfectas condiciones.
- Asegúrese que el lugar de instalación cumple con las medidas de seguridad.
- La instalación debe realizarse por personal cualificado.
- El fabricante no se responsabiliza de los daños causados por un mal trato o una mala instalación del producto.
- El producto cumple la normativa *EN 13561 Toldos. Requisitos de prestaciones* incluida la seguridad, y *EN 1932 Celosías exteriores y persianas. Resistencia a las cargas de viento. Método de ensayo y criterios de prestaciones*, y ha salido de fábrica en perfectas condiciones.
- Es preciso disponer de las herramientas y la indumentaria adecuada para su instalación como guantes, gafas protectoras y calzado de seguridad.
- Si el modelo dispone de motor eléctrico, lea atentamente las instrucciones del fabricante antes de su instalación.

## RESPONSABILIDAD

El fabricante no se responsabiliza de los daños ocasionados a personas o a la propia instalación, debido al incumplimiento de las instrucciones recogidas en este manual sobre la instalación, el uso y el mantenimiento. También por acciones violentas o maniobras incorrectas y por modificaciones realizadas sin autorización por escrito.

Para las operaciones de mantenimiento o reparación se deberán utilizar exclusivamente piezas de repuesto originales. El producto está garantizado según los acuerdos estipulados en la venta. Por ello, la garantía y el marcado CE decaerán en el caso de inobservancia de las normas e instrucciones de uso proporcionadas en este manual.

## REQUISITOS DEL USUARIO Y DEL INSTALADOR

Estos sistemas están exclusivamente destinados al uso para el cual fueron diseñados. Cualquier otro uso es inadecuado, y por lo tanto peligroso. De ningún modo, se deberá instalar un producto deteriorado ya que puede causar daños a la propia instalación, así como crear situaciones peligrosas.

**La instalación se debe realizar siempre por un instalador profesional. En caso de dudas o de un uso no previsto, póngase en contacto con LaViuda antes de la instalación.**

# AURA / ÁGORA ZIP

## INSTALACIÓN DEL CAJÓN

Comprobar el ensamblaje del cajón e introducir las guías interiores en los testeros hasta que queden enrasadas.

Colocar en su posición:

- (A) Instalación en interior hueco.
- (B) Instalación en exterior fachada.
- (C) Instalación autoportante.

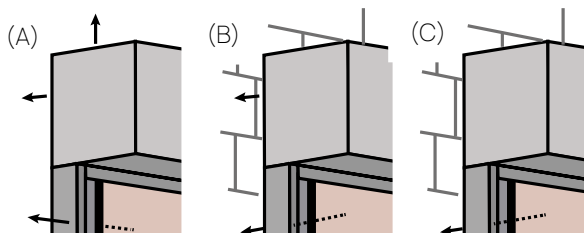
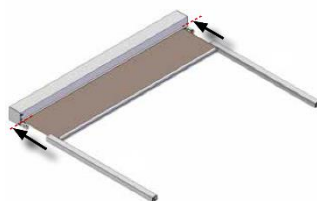

## INSTALACIÓN DEL CAJÓN CON SOPORTES

Fijar los soportes correspondientes dependiendo si el montaje es en techo o pared, siguiendo el esquema de instalación y utilizando los sistemas de fijación recomendados.

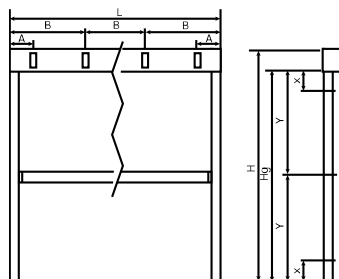

(ESQUEMA DE INSTALACIÓN)

L		A	B	H		X	Y
soportes				orificio de fijación			
0-1500	2	150	-	0-1000	2	90	-
1501-3000	3	150	L/2	1001-2000	3	90	Hg / 2
3001-4000	4	150	L/3	2001-2500	4	90	Hg / 3
4001-5000	5	150	L/4	3001-4000	5	90	Hg/4
5001-6500	6	150	L/5	4001-5000	6	90	Hg/5
6501-8000	7	150	L/6	5001-6000	7	90	Hg/6







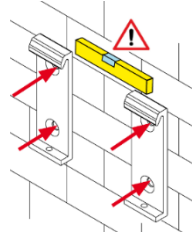







SISTEMAS DE FIJACIÓN RECOMENDADOS		
HSL-3-SK		HORMIGÓN
Hilti HRD-U10 Hilti HRD-S10		HORMIGÓN LADRILLO PERFORADO
HUD-1 HUD-L		LADRILLO MACIZO

*En entornos corrosivos, se recomienda utilizar anclajes de acero inoxidable*

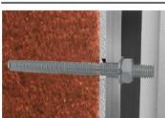

## Secuencia operativa de colocación de los anclajes:

ANCLAJE MECÁNICO		ANCLAJE QUÍMICO	
	<b>1</b> Realice un orificio mediante la broca del taladro apropiada al tipo de anclaje.		<b>1</b> Realice un orificio mediante la broca del taladro apropiada al tipo de anclaje.
	<b>2</b> Preste atención a la profundidad de ejecución del orificio.		<b>2</b> Preste atención a la profundidad de ejecución del orificio.
	<b>3</b> Haga salir el polvo y los fragmentos del orificio (es ideal el uso de aire comprimido).		<b>3</b> Haga salir el polvo y los fragmentos del orificio con un cepillo.
	<b>4</b> Instale el anclaje.		<b>4</b> Haga salir el polvo residual con el uso de aire comprimido.
	<b>5</b> Apriete hasta alcanzar el par de apriete recomendado (ver el catálogo Hilti).		<b>5</b> Inyecte el adhesivo químico.
	<b>6</b> Configuración final.		<b>6</b> Introduzca y ajuste el anclaje respetando el tiempo de reposo antes de colocar la placa (ver el cartucho del producto.)
			<b>7</b> Colocar la placa y apretar hasta el par de apriete recomendado (ver el catálogo Hilti).

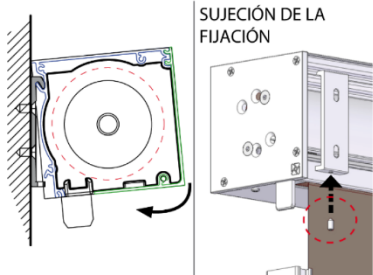

**Anclaje a pared:** Colocar el cajón en su posición y fijarlo por la parte posterior.

**Anclaje en techo:** retirar la tapa para acceder al soporte. Colocar el cajón sobre las pestañas del soporte y fijarlo atornillando el tornillo prisionero del soporte sobre el perfil.

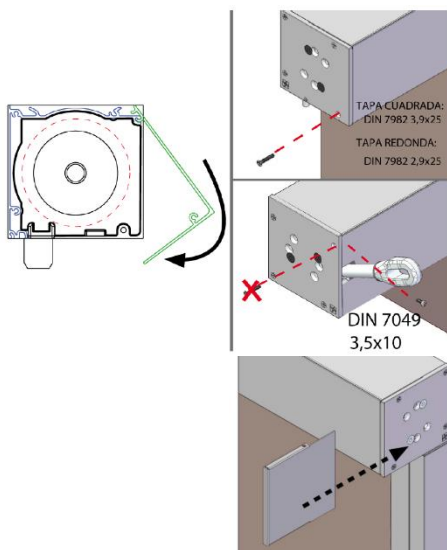
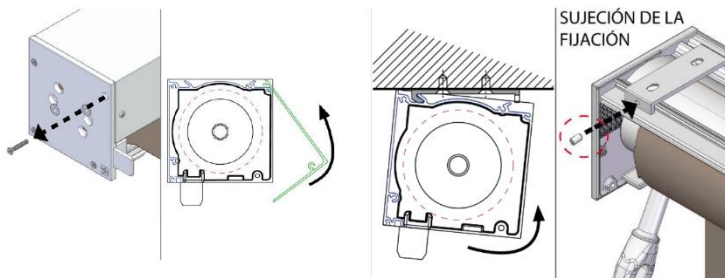

\*En instalación de interior hueco, la tapa debe fijarse por la cara interior, nunca por el lateral, con el fin de permitir su registro posterior.

Deslizar las tapas embellecedoras sobre los testeros laterales (si procede).

## INSTALACIÓN DE LAS GUÍAS

Colocar las tapas en las guías y fijarlas con tornillos DIN 7982 3,5x25. Introducir las guías de manera que queden enrasadas con los testeros. Situar en su posición, bien sea interior hueco, exterior fachada o empotrada, siguiendo el esquema de montaje anterior.

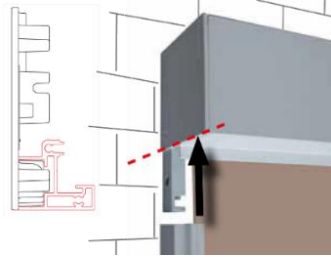

Colocadas las guías, descender el toldo por completo y comprobar que estén niveladas. Posteriormente, cerrar el toldo y fijar las guías.

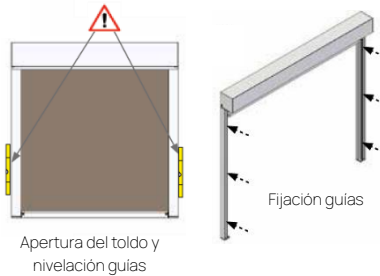

Atornillar las guías, utilizando tornillos DIN 7981 M3,9x16 de acuerdo a la siguiente posición:

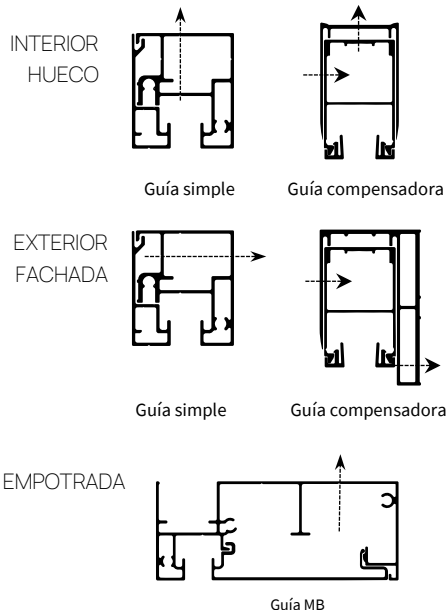



Con el toldo en la parte superior, introducir la guía interior ZIP en la cremallera del tejido.

Una vez colocada, insertar la cubierta (A) de la guía a presión.

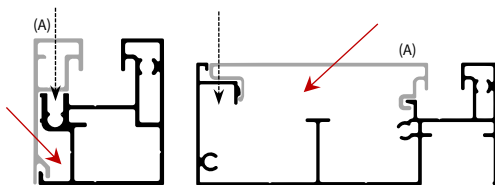

Para la **guía compensadora**:



Fijar la guía compensadora (aloha-guías) y el cajón. La pata del testero debe encajar en el alojamiento del perfil.

Introducir la guía ZIP dentro de la guía compensadora.



La cremallera debe introducirse dentro del perfil carril interior. Es muy importante verificar este punto.

Una vez introducido el tejido, bajar la tela hasta el punto inferior.

En su movimiento descendente, el perfil se recoloca por sí mismo.

Una vez recolocado, es necesario fijar la guía ZIP a la guía compensadora mediante tornillos, estos quedarán vistos en la cara plana.

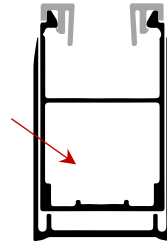

## REGULACIÓN DEL TOLDO

Ajustar los finales de carrera del motor si fuese necesario. Para el correcto funcionamiento del toldo, subir y bajar completamente la tela varias veces para posicionarlo adecuadamente.

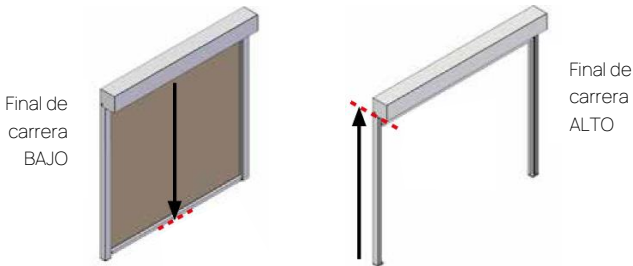

**Extendida la lona, esta puede presentar arrugas o marcas al haber estado enrollada durante largo tiempo. Esto NO representa un problema ya que estas marcas, por las condiciones ambientales exteriores, desaparecerán con el tiempo al estabilizarse.**

# NUVOLA

## ZIP

### INSTALACIÓN DE LOS TESTEROS

Unir los pernos a los testers y colocarlos en su posición. Introducir las guías interiores hasta que queden enrasadas. Fijar según montaje:

- (A) Instalación en interior hueco.
- (B) Instalación en exterior fachada.
- (C) Instalación autoportante.

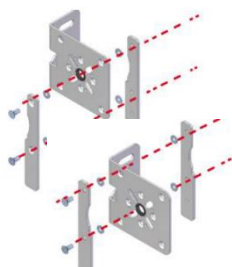

SISTEMAS DE FIJACIÓN RECOMENDADOS		
HSL-3-SK		HORMIGÓN
Hilti HRD-U10 Hilti HRD-S10		HORMIGÓN LADRILLO PERFORADO LADRILLO MACIZO
HUD-1 HUD-L		

*En entornos corrosivos, se recomienda utilizar anclajes de acero inoxidable*

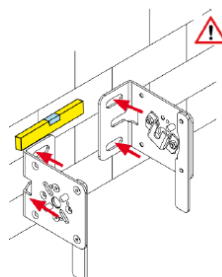

*\*Ver secuencia del sistema de anclaje en pág.7*

Introducir el cilindro y su junta en el lado libre del eje y colocar en los testers. Introducir los pasadores en la cabeza del motor y en el lado libre para fijarlo.

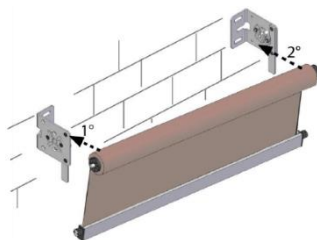
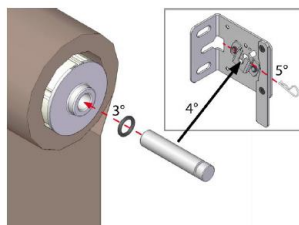

## INSTALACIÓN DE LAS GUÍAS

Colocar las tapas en las guías y fijarlas con tornillos DIN 7982 3,5x25.

Introducir las guías por los pernos y observar que estén colocadas a nivel.

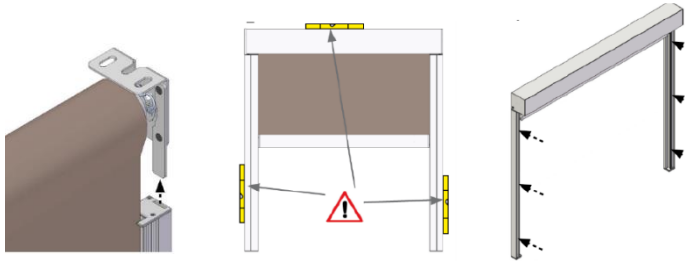

Situar en su posición, bien sea interior hueco, exterior fachada o empotrada, siguiendo el esquema de montaje anterior. Atornillar las guías, utilizando tornillos DIN 7981 M3,9x16 de acuerdo a la siguiente posición:

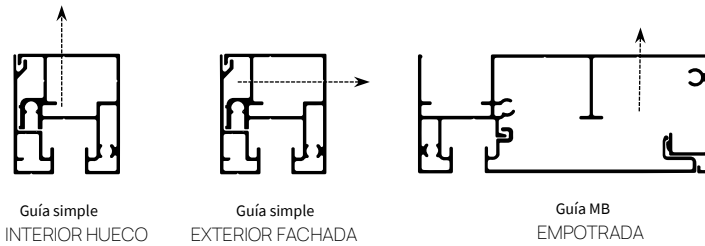

Una vez estén fijadas las guías en su posición, introducir las guías interiores ZIP, de tal manera que la cremallera quede en su interior.

Cerrar el conjunto con la cubierta de la guía.

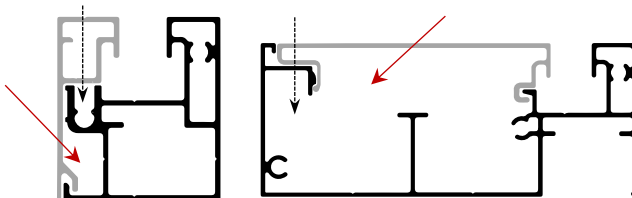

### REGULACIÓN DEL TOLDO

Ajustar los finales de carrera del motor si fuese necesario. Para el correcto funcionamiento del toldo, subir y bajar completamente la tela varias veces para posicionarlo adecuadamente.

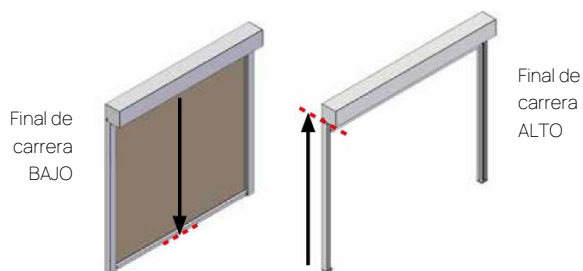

**Extendida la lona, esta puede presentar arrugas o marcas al haber estado enrollada durante largo tiempo. Esto NO representa un problema ya que estas marcas, por las condiciones ambientales exteriores, desaparecerán con el tiempo al estabilizarse.**



## AURA / ÁGORA GUÍA

### INSTALACIÓN DEL CAJÓN

Colocar los testeros en su posición e introducir las guías interiores hasta que queden enrasadas. Fijar según montaje:

- (A) Instalación en interior hueco.
- (B) Instalación en exterior fachada.
- (C) Instalación autoportante.

### INSTALACIÓN DEL CAJÓN CON SOPORTES

De manera opcional se puede sujetar el cajón mediante soportes. Para ello, se deben colocar y fijar, asegurando que queden nivelados.

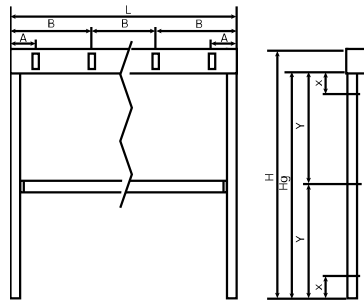

(ESQUEMA DE INSTALACIÓN)

L	A	B	H	X	Y		
soportes		orificio de fijación					
0-1500	2	150	-	0-1000	2	90	-
1501-3000	3	150	L/2	1001-2000	3	90	Hg / 2
3001-4000	4	150	L/3	2001-3000	4	90	Hg / 3
4001-5000	5	150	L/4	3001-4000	5	90	Hg/4
			4001-5000	6	90	Hg/5	

### SISTEMAS DE FIJACIÓN RECOMENDADOS

HSL-3-SK		HORMIGÓN
Hilti HRD-U10 Hilti HRD-S10		HORMIGÓN LADRILLO PERFORADO LADRILLO MACIZO
HUD-1		
HUD-L		

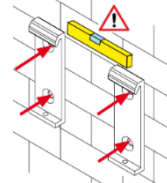

*En caso de entorno corrosivo, se recomienda utilizar anclajes de acero inoxidable*

**\*Ver secuencia del sistema de anclaje en pág.7**

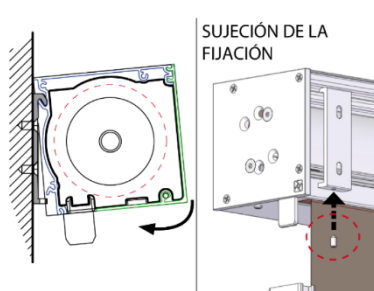

**Anclaje a pared:**

colocar el cajón en su posición y fijarlo por la parte posterior.

**Anclaje en techo:** retirar la tapa para acceder al soporte. Colocar el cajón sobre las pestañas del soporte y fijarlo atornillando el tornillo prisionero del soporte sobre el perfil.

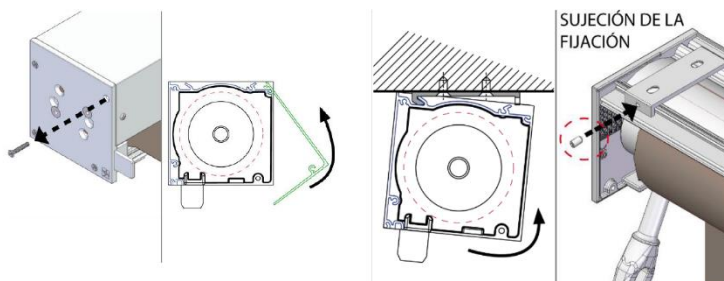

INSTALACIÓN DE LAS GUÍAS

Colocar las tapas en las guías y fijarlas con tornillos DIN 7982 3,5x25. Introducir las guías por los pernos del testero y observar que estén colocadas a nivel.

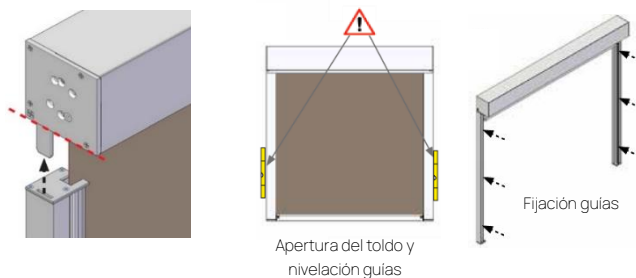

Situar en su posición, bien sea interior hueco, exterior fachada o empotrada, siguiendo el esquema de montaje anterior. Atornillar las guías usando tornillos DIN 7981 M3,9x16.

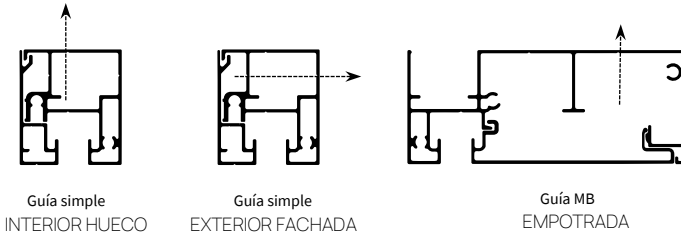

## REGULACIÓN DEL TOLDO

Ajustar los finales de carrera del motor si fuese necesario. Para el correcto funcionamiento del toldo, subir y bajar completamente la tela varias veces para posicionarlo adecuadamente.

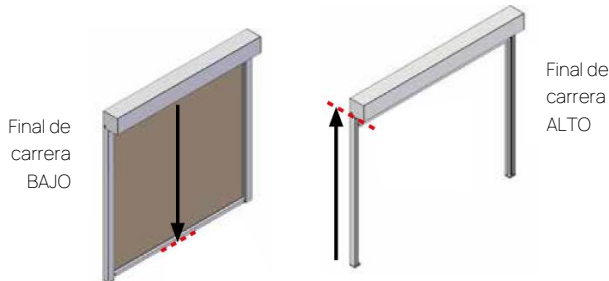

**Extendida la lona, esta puede presentar arrugas o marcas al haber estado enrollada durante largo tiempo. Esto NO representa un problema ya que estas marcas, por las condiciones ambientales exteriores, desaparecerán con el tiempo al estabilizarse.**

## NUVOLA GUÍA

### INSTALACIÓN DE LOS TESTEROS

Unir los pernos a los testeros y colocarlos en su posición. Introducir las guías interiores hasta que queden enrasadas. Fijar según montaje:

- (A) Instalación en interior hueco.
- (B) Instalación en exterior fachada.
- (C) Instalación autoportante.

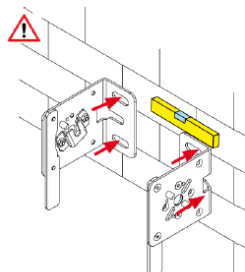

### SISTEMAS DE FIJACIÓN RECOMENDADOS

HSL-3-SK		HORMIGÓN
Hilti HRD-U10 Hilti HRD-S10		HORMIGÓN LADRILLO PERFORADO
HUD-1 HUD-L		LADRILLO MACIZO

*En entornos corrosivos, se recomienda utilizar anclajes de acero inoxidable*

*\*Ver secuencia del sistema de anclaje en pág.7*

Introducir el cilindro con su junta en el lado libre del eje.

Colocar el eje en los testeros. Introducir los pasadores en la cabeza del motor y en el lado libre para fijarlo.

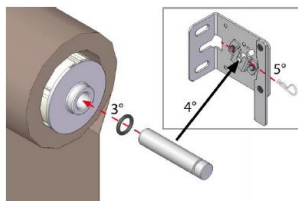
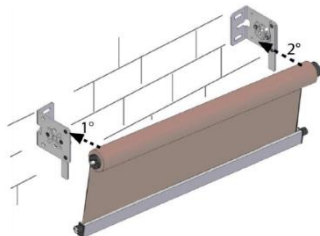

## INSTALACIÓN DE LAS GUÍAS

Colocar las tapas en las guías y fijarlas con tornillos DIN 7982 3,5x25. Introducir las guías por los pernos del testero y observar que estén colocadas a nivel. Situar en su posición, bien sea interior hueco, exterior fachada o empotrada, siguiendo el esquema de montaje anterior. Atornillar las guías usando tornillos DIN 7981 M3,9x16.

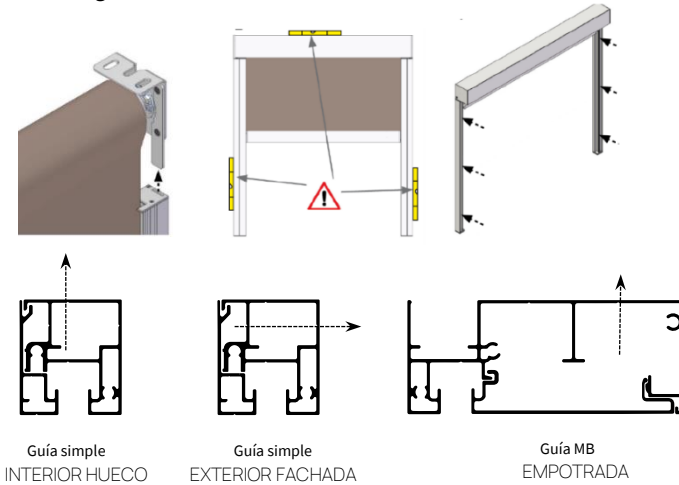

## REGULACIÓN DEL TOLDO

Ajustar los finales de carrera del motor si fuese necesario. Para el correcto funcionamiento del toldo, subir y bajar completamente la tela varias veces para posicionarlo adecuadamente.

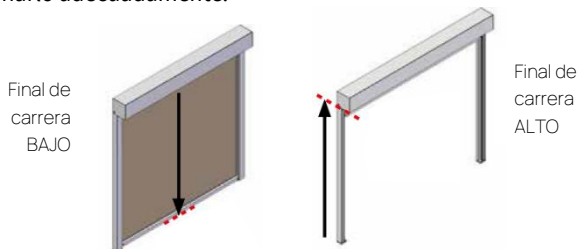

**Extendida la lona, esta puede presentar arrugas o marcas al haber estado enrollada durante largo tiempo. Esto NO representa un problema ya que estas marcas, por las condiciones ambientales exteriores, desaparecerán con el tiempo al estabilizarse.**

## AURA / ÁGORA CABLE

### INSTALACIÓN DEL CAJÓN

Colocar los testeros en su posición y fijar según montaje:

- (A) Instalación en interior hueco.
- (B) Instalación en exterior fachada.

### INSTALACIÓN DEL CAJÓN CON SOPORTES

De manera opcional se puede sujetar el cajón mediante soportes. Para ello, se deben colocar y fijar, asegurando que queden nivelados.

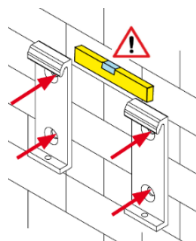

(ESQUEMA DE INSTALACIÓN)

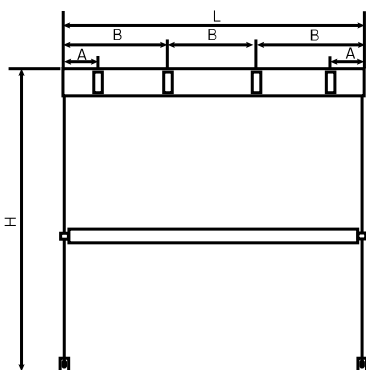

L	A	B
0-1500 L (soportes) 2	150	B
1501-3000 0-1500	2	150
3001-4000 1501-3000	3	150
4001-5000 3001-4000	4	150
4001-5000	5	150

### SISTEMAS DE FIJACIÓN RECOMENDADOS

HSL-3-SK		HORMIGÓN
Hilti HRD-U10 Hilti HRD-S10		HORMIGÓN LADRILLO PERFORADO
HUD-1 HUD-L		LADRILLO MACIZO

*En entornos corrosivos, se recomienda utilizar anclajes de acero inoxidable*

*\*Ver secuencia del sistema de anclaje en pág.7*

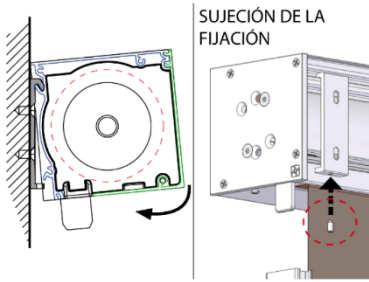

**Anclaje a pared:** colocar el cajón en su posición y fijarlo por la parte posterior.

**Anclaje en techo:** retirar la tapa para acceder al soporte. Colocar el cajón sobre las pestañas del soporte y fijarlo atornillando el tornillo prisionero del soporte sobre el perfil.

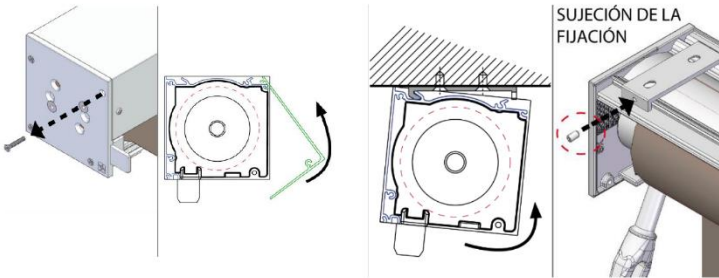

## FIJACIÓN DEL CABLE

Colocar el cable siguiendo el esquema siguiente. Fijando al testero, al terminal y al soporte.

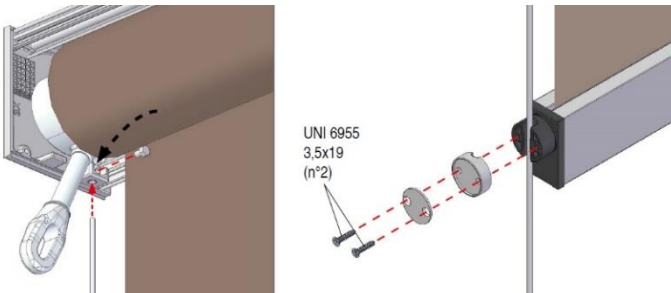

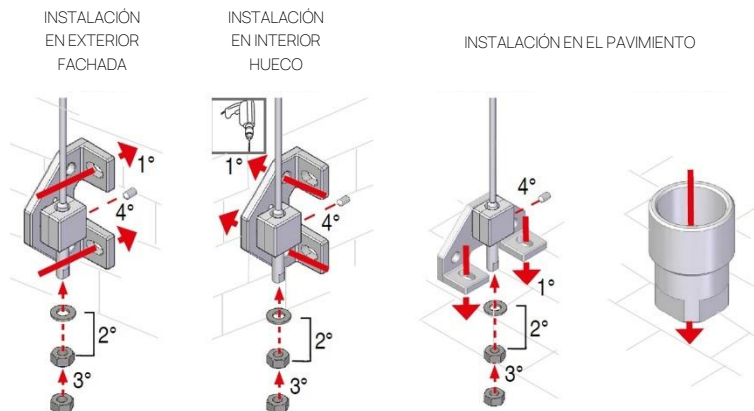

### REGULACIÓN DEL TOLDO

Ajustar los finales de carrera del motor si fuese necesario. Para el correcto funcionamiento del toldo, subir y bajar completamente la tela varias veces para posicionarlo adecuadamente.

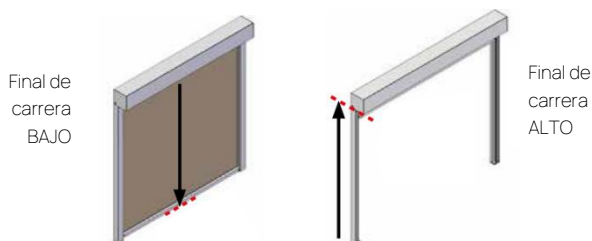

**Extendida la lona, esta puede presentar arrugas o marcas al haber estado enrollada durante largo tiempo. Esto NO representa un problema ya que estas marcas, por las condiciones ambientales exteriores, desaparecerán con el tiempo al estabilizarse.**



## NUVOLA CABLE

### INSTALACIÓN DE LOS TESTEROS

Unir los pernos a los testeros y colocarlos en su posición. Introducir las guías interiores hasta que queden enrasadas. Fijar según montaje:

- (A) Instalación en interior hueco.
- (B) Instalación en exterior fachada.



SISTEMAS DE FIJACIÓN RECOMENDADOS		
HSL-3-SK		HORMIGÓN
Hilti HRD-U10 Hilti HRD-S10		HORMIGÓN LADRILLO PERFORADO LADRILLO MACIZO
HUD-1 HUD-L		

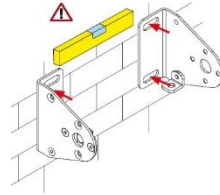

*En entornos corrosivos, se recomienda utilizar anclajes de acero inoxidable*

*\*Ver secuencia del sistema de anclaje en pág.7*

Introducir el cilindro con su junta en el lado libre del eje.

Colocar el eje en los testeros. Introducir los pasadores en la cabeza del motor y en el lado libre para fijarlo.

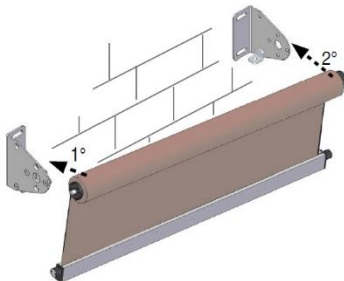
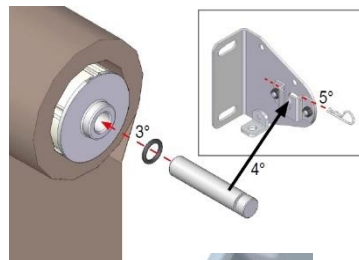

## FIJACIÓN DEL CABLE

Colocar el cable siguiendo el esquema siguiente. Fijar al testero, al terminal y al soporte.

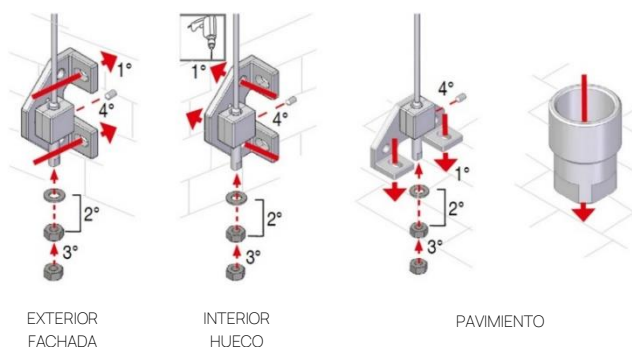
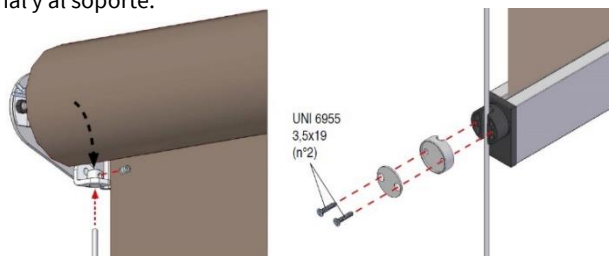

## REGULACIÓN DEL TOLDO

Ajustar los finales de carrera del motor si fuese necesario. Para el correcto funcionamiento del toldo, subir y bajar completamente la tela varias veces para posicionarlo adecuadamente.

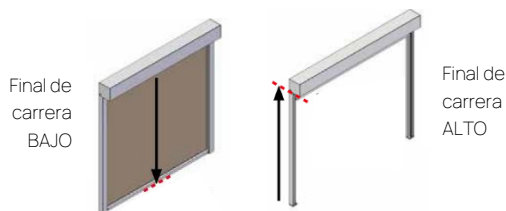

**Extendida la lona, esta puede presentar arrugas o marcas al haber estado enrollada durante largo tiempo. Esto NO representa un problema ya que estas marcas, por las condiciones ambientales exteriores, desaparecerán con el tiempo al estabilizarse.**

## AURA / ÁGORA VARILLA

### INSTALACIÓN DEL CAJÓN

Colocar los testers en su posición y fijar según montaje:

- (A) Instalación en interior hueco
- (B) Instalación en exterior fachada

### INSTALACIÓN DEL CAJÓN CON SOPORTES

De manera opcional se puede sujetar el cajón mediante soportes. Para ello, se deben colocar y fijar, asegurando que queden nivelados.

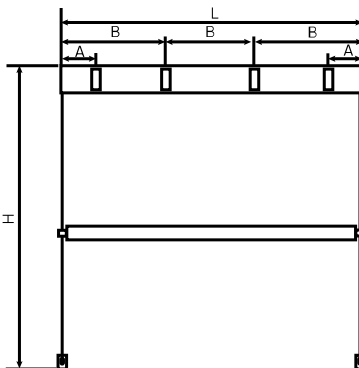
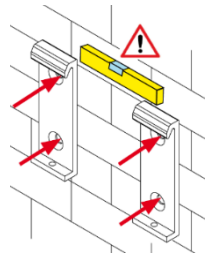

(ESQUEMA DE INSTALACIÓN)

L	A	B
0-1500 soportes 2	150	-B
1500-3000 soportes 3	150	L/2
3000-4500 soportes 4	150	L/3
4500-5000 soportes 5	150	L/4

### SISTEMAS DE FIJACIÓN RECOMENDADOS

HSL-3-SK		HORMIGÓN
Hilti HRD-U10 Hilti HRD-S10		HORMIGÓN LADRILLO PERFORADO
HUD-1 HUD-L		LADRILLO MACIZO

*En entornos corrosivos, se recomienda utilizar anclajes de acero inoxidable*

*\*Ver secuencia del sistema de anclaje en pág.7*

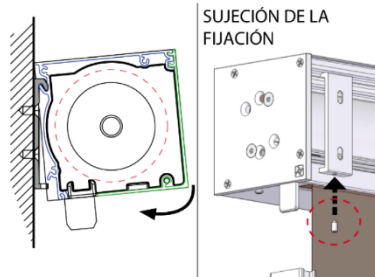

**Anclaje a pared:**  
colocar el cajón en su posición y fijarlo por la parte posterior.

**Anclaje en techo:** retirar la tapa para acceder al soporte. Colocar el cajón sobre las pestañas del soporte y fijarlo atornillando el tornillo prisionero del soporte sobre el perfil.

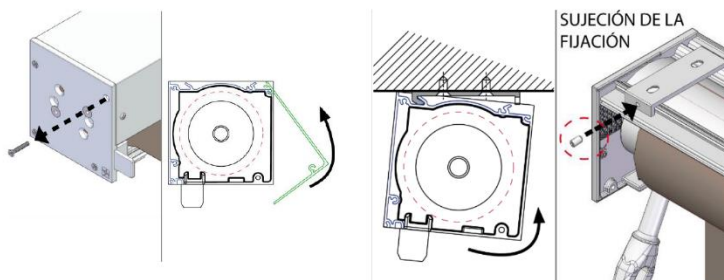

**FIJACIÓN DE LA VARILLA**

Colocar la varilla siguiendo el esquema siguiente. Fijar al testero, al terminal y al soporte.

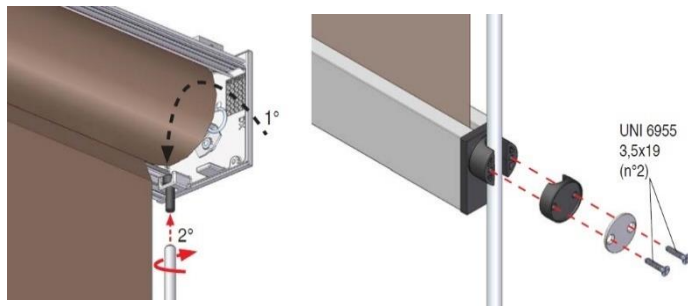

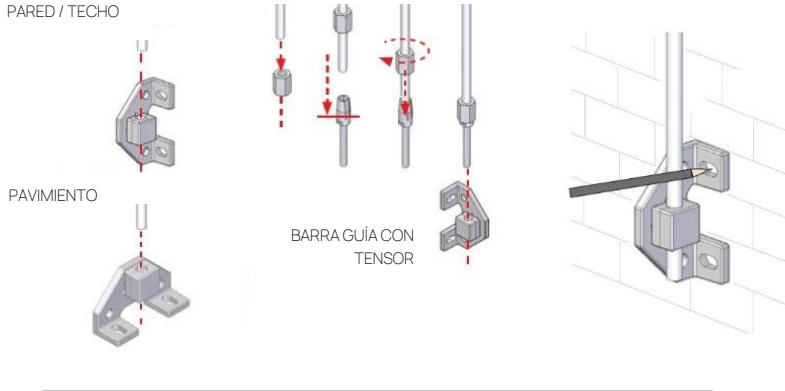

## REGULACIÓN DEL TOLDO

Ajustar los finales de carrera del motor si fuese necesario. Para el correcto funcionamiento del toldo, subir y bajar completamente la tela varias veces para posicionarlo adecuadamente.

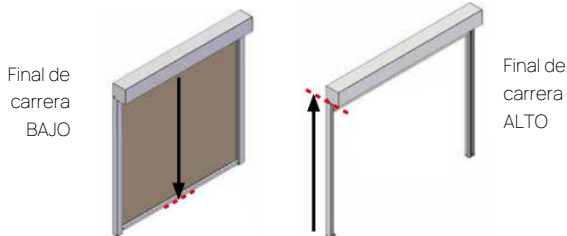

**Extendida la lona, esta puede presentar arrugas o marcas al haber estado enrollada durante largo tiempo. Esto NO representa un problema ya que estas marcas, por las condiciones ambientales exteriores, desaparecerán con el tiempo al estabilizarse.**

## NUVOLA VARILLA

### INSTALACIÓN DE LOS TESTEROS

Unir los pernos a los testeros y colocarlos en su posición. Introducir las guías interiores hasta que queden enrasadas.

Fijar según montaje:

- (A) Instalación en interior hueco.
- (B) Instalación en exterior fachada.

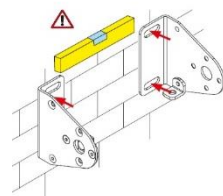

### SISTEMAS DE FIJACIÓN RECOMENDADOS

HSL-3-SK		HORMIGÓN
Hilti HRD-U10 Hilti HRD-S10		HORMIGÓN LADRILLO PERFORADO
HUD-1 HUD-L		LADRILLO MACIZO

*En entornos corrosivos, se recomienda utilizar anclajes de acero inoxidable*

*\*Ver secuencia del sistema de anclaje en pág.7*

Introducir el cilindro con su junta en el lado libre del eje.

Colocar el eje en los testeros. Introducir los pasadores en la cabeza del motor y en el lado libre para fijarlo.

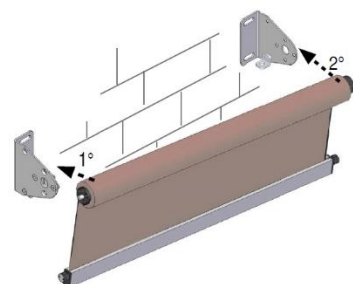
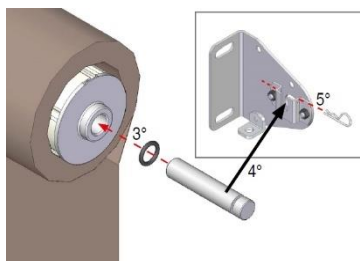

## FIJACIÓN DE LA VARILLA

Colocar la varilla siguiendo el esquema siguiente. Fijar al testero, al terminal y al soporte.

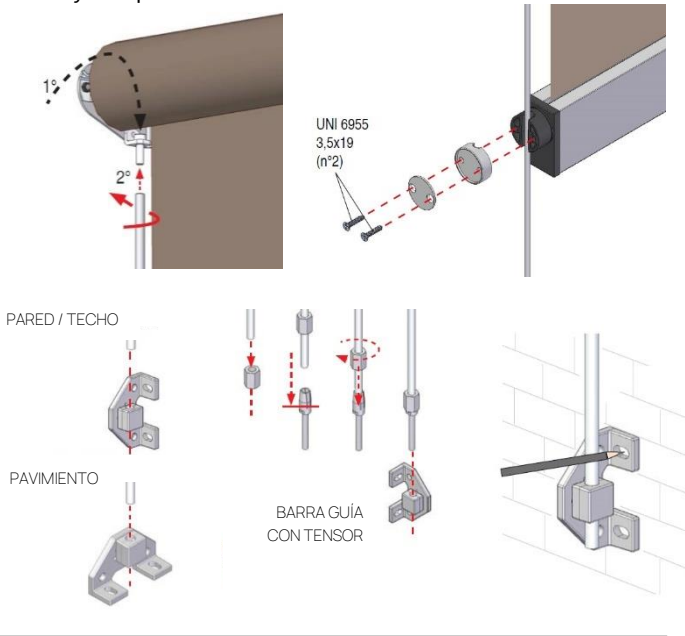

## REGULACIÓN DEL TOLDO

Ajustar los finales de carrera del motor si fuese necesario. Para el correcto funcionamiento del toldo, subir y bajar completamente la tela varias veces para posicionarlo adecuadamente.

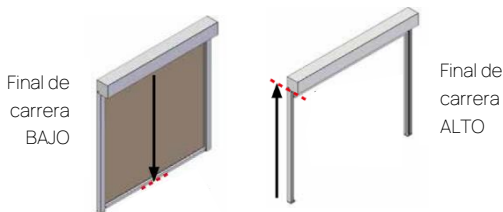

**Extendida la lona, esta puede presentar arrugas o marcas al haber estado enrollada durante largo tiempo. Esto NO representa un problema ya que estas marcas, por las condiciones ambientales exteriores, desaparecerán con el tiempo al estabilizarse.**

## MOTOR

### INSTALACIÓN

La instalación del motor Senso RX de Cherubini deberá realizarla un profesional de la motorización y la automatización de la vivienda, a quien va dirigida esta guía.

El instalador deberá, además, cumplir las normativas y la legislación vigente en el país de instalación y deberá informar a sus clientes sobre las condiciones de uso y mantenimiento del producto. Cualquier uso diferente de la aplicación establecida por Cherubini se considerará un uso inadecuado. Esto, junto con cualquier incumplimiento de las instrucciones que figuran en esta guía, conllevará la exclusión de la responsabilidad y garantía por parte de Cherubini.

### CONEXIÓN ELÉCTRICA

Para evitar mal funcionamiento o situaciones de peligro, los elementos eléctricos de mando conectados al motor, tienen que ser dimensionados según las características eléctricas del propio motor.

- La desconexión de un dispositivo deber estar prevista en la red eléctrica conforme a las reglas de instalación nacionales
- En el caso de utilización en el exterior, utilizar un cable de alimentación con designación H05RN-F con un contenido mínimo en carbón del 2%
- Si el cable blanco no es utilizado debe ser aislado siempre. Es peligroso tocar el cable blanco cuando el motor está conectado a corriente
- La instalación del pulsador es opcional, conectándose a Fase (cable marrón) o a Neutro (cable azul) indistintamente. Con el pulsador, el motor funcionará en modalidad paso a paso (subida, stop, bajada, stop ...)

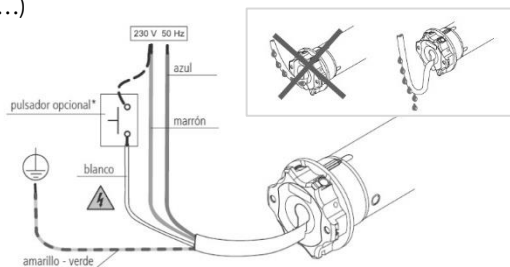



## PUESTA EN MARCHA

### (I) Apertura de la programación del emisor

Para evitar modificaciones accidentales en la programación del motor durante el uso, la posibilidad de realizar programaciones se deshabilita automáticamente transcurridas 8 horas de la última secuencia.

- APERTURA/CIERRE EN EMISORES POP PLUS / POP LUX / POP PLUX / SKIPPER PLUS / SKIPPER LUX / SKIPPER PLUX
  - Comprobar el estado de la función

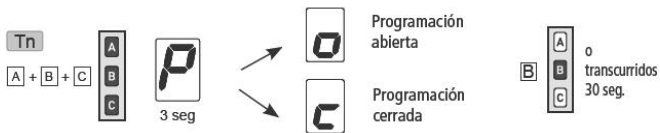

- Habilitar la programación

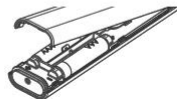

Quitar y poner las pilas

- Deshabilitar la programación



- APERTURA/CIERRE EN EMISORES SKIPPER / SERIE GIRO / EMISOR POP
  - Comprobar el estado de la función

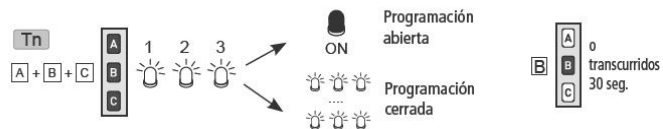

- Habilitar la programación

OPCIÓN 1



OPCIÓN 2

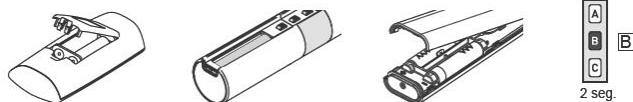

- Deshabilitar la programación



- MEMORIZACIÓN DEL PRIMER EMISOR
 

Esta operación se realiza cuando el motor es nuevo o se realiza una cancelación total de la memoria del motor. Durante esta fase, para evitar interferencias, alimentar un solo motor.

Las teclas deben ser pulsadas tal y como se indica en la secuencia, sin que transcurran más de 4 segundos entre un paso y el otro. Si no es así, la orden no será aceptada y se deberá repetir.

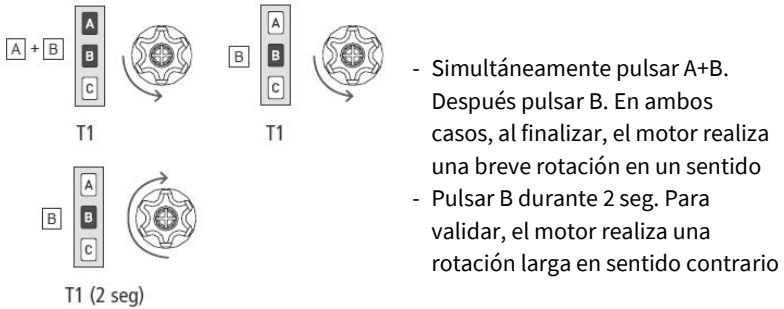

A continuación, dos ejemplos de secuencias incompletas:

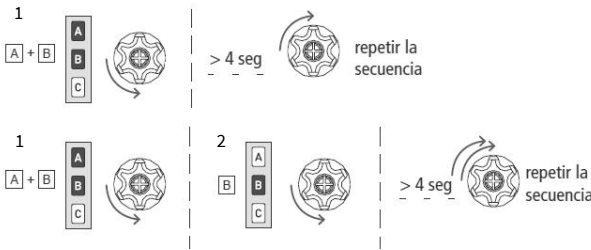

Cada vez que damos corriente al motor se dispone de tres horas para la memorización del primer emisor. Transcurrido este tiempo, queda deshabilitada la opción de memorizar el primer emisor. Para reestablecer el tiempo de la función, quitar y dar corriente.

▪ MEMORIZACIÓN DE OTROS EMISORES

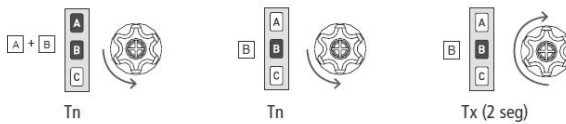

Tn: Emisor ya memorizado

Tx: Emisor a memorizar

■ CANCELACIÓN DE UN EMISOR

Es posible cancelar individualmente todos los emisores memorizados. Tras cancelar el último, el motor vuelve a las condiciones iniciales.

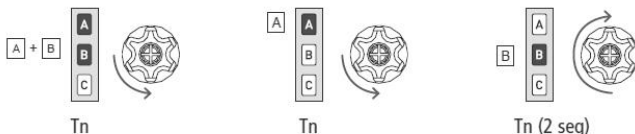

Tn: Emisor ya memorizado

■ CANCELACIÓN TOTAL DE EMISORES

- Desde el emisor:

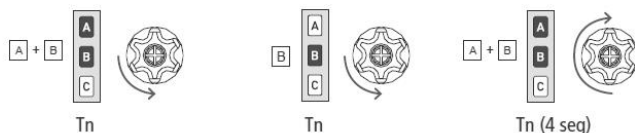

Tn: Emisor ya memorizado

- Desde el cable auxiliar (utilizar en caso de emergencia):

- 1.Desconectar la corriente mediante el automático
- 2.Unir cable blanco al marrón (fase) o azul (neutro)
- 3.Alimentar el motor
- 4.Volver a desconectar el motor de corriente (4 segundos)
- 5.Volver a alimentar el motor. tras 4 seg. el motor realizará una breve rotación, y una rotación más larga en sentido contrario
- 6.Desconectar el motor de corriente
- 7.Separar el cable blanco del marrón/azul. Aislar debidamente el cable antes de conectar a corriente.

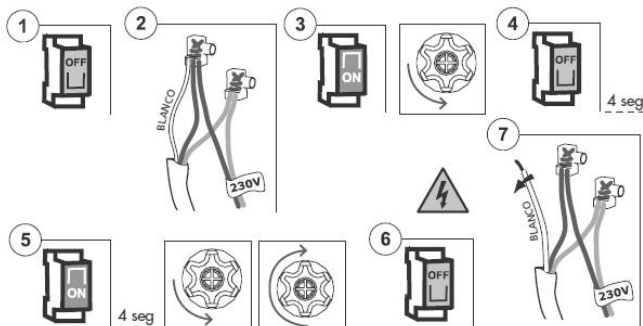

## (II) Ajuste finales de carrera

### REGULACIÓN DEL FIN DE CARRERA DE CIERRE

- Recoger el toldo hasta la posición de cierre
- Fijar manteniendo pulsado "STOP" hasta que el motor realice una rotación en bajada

Si el toldo está completamente cerrado:

- Bajar unos 20 cm. Es posible que sea necesario utilizar la tecla de subida, porque el sentido correcto de rotación será identificado solo después de haber memorizado la posición de cierre
- Fijar la posición correcta pulsando "STOP" hasta que el motor realice una rotación en bajada.

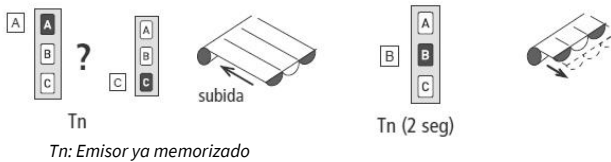

### REGULACIÓN DEL FIN DE CARRERA DE APERTURA

- Llevar el toldo hasta la posición de apertura, manteniendo la tecla de bajada del emisor
- Fijar la posición manteniendo pulsado 2 segundos "STOP" hasta que el motor realice una rotación en subida.

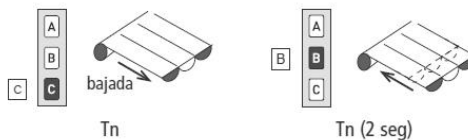

*Tn: Emisor ya memorizado*

■ CANCELACIÓN DEL FIN DE CARRERA DE CIERRE

- Seguir la siguiente secuencia y proceder nuevamente con la regulación del fin de carrera de cierre:

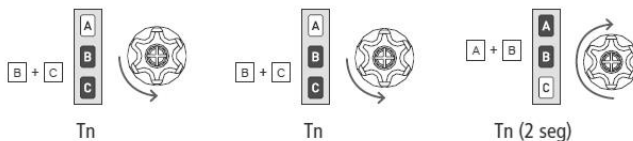

Tn: Emisor ya memorizado

■ CANCELACIÓN DEL FIN DE CARRERA DE APERTURA

- Seguir la siguiente secuencia y proceder nuevamente con la regulación del fin de carrera de apertura:

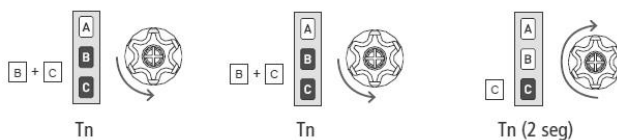

Tn: Emisor ya memorizado

■ CANCELACIÓN TOTAL DE LOS FINES DE CARRERA

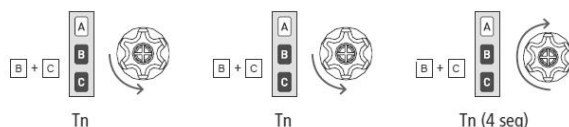

Tn: Emisor ya memorizado

(III) Funciones avanzadas

■ POSICIÓN INTERMEDIA

Memorización posición intermedia:

- Situar el toldo en la posición preferida
- Pulsar “STOP” durante 4 segundos hasta confirmación del motor
- Una vez memorizada, para llevar el toldo a esta posición, pulsar “STOP” durante 2 segundos

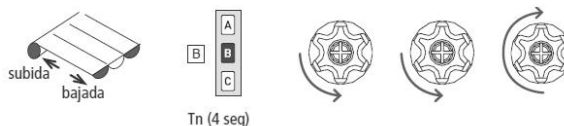

Tn: Emisor ya memorizado

## Posición intermedia adicional:

- Posición útil para que el toldo se abra de forma automática por medio del sensor WindTec Lux
- Para regular la posición, primero memorizar los fines de carrera y después ejecutar la siguiente secuencia

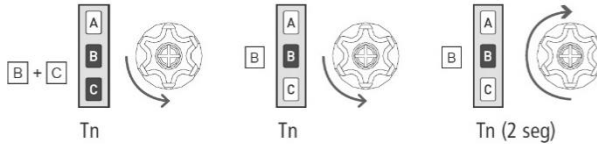

*Tn: Emisor ya memorizado*

- Ahora el motor está en “Hombre presente” y permite ejecutar con precisión esta posición
- Mover el toldo hasta la posición de apertura deseada
- Pulsar B durante 2 seg. hasta que el motor confirme

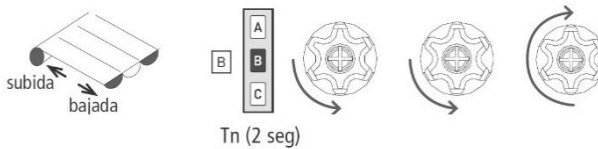

- Cuando WindTec Lux accione la apertura con el automatismo luz, el toldo se colocará en la posición intermedia adicional.

## Cancelación posición intermedia:

- Se realiza si no se desea disponer de tal función y para modificar la posición intermedia ya memorizada
- ANTES DE CANCELAR, llevar toldo a dicha posición intermedia pulsando “STOP” durante 2 segundos
- Pulsar “STOP” durante 4 segundos hasta que el motor efectúe la señal de confirmación

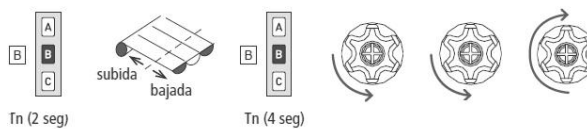

*Tn: Emisor ya memorizado*

▪ REGULACIÓN DE LA FUERZA DE CIERRE

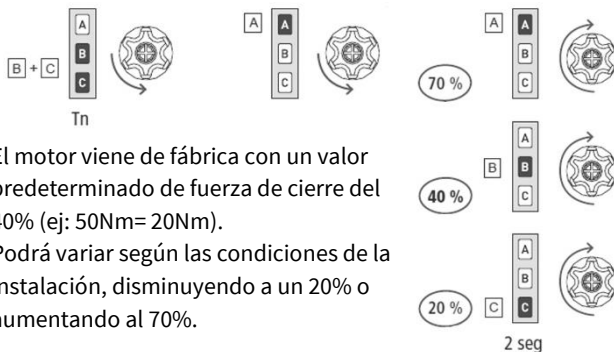

El motor viene de fábrica con un valor predeterminado de fuerza de cierre del 40% (ej: 50Nm= 20Nm).

Podrá variar según las condiciones de la instalación, disminuyendo a un 20% o aumentando al 70%.

▪ POSICIÓN TENSADO LONA

Al habilitar esta función, cuando se alcanza la posición de apertura, el motor realiza un retroceso automático de la amplitud programada, que tensiona la lona. Esta posición se debe programar después memorizar los finales de carrera.

- INICIO DEL PROCEDIMIENTO DE MEMORIZACIÓN DE LA POSICIÓN OPCIONAL

Con esta secuencia permite un ajuste milimétrico de la tensión, ya que lleva al toldo a la máxima apertura y prepara al motor para el funcionamiento “HOMBRE PRESENTE”.

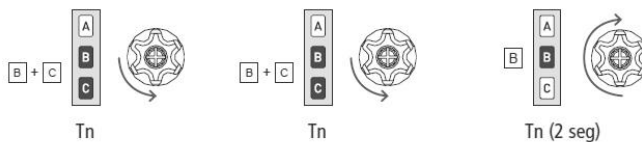

Tn: Emisor ya memorizado



## - AJUSTE Y CONVALIDACIÓN DE LA POSICIÓN OPCIONAL

Tras ajustar y confirmar la posición, el toldo realiza una apertura a posición máxima y un retorno a la nueva posición.

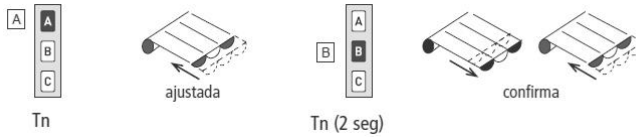

*Tn: Emisor ya memorizado*

## - BORRADO DE LA POSICIÓN OPCIONAL

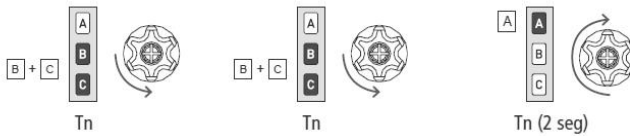

*Tn: Emisor ya memorizado*

## ■ GESTIÓN MODALIDAD DE MANDO

Hay tres configuraciones posibles. Para pasar de una configuración a otra, repetir la secuencia hasta llegar a la configuración deseada. Están disponibles en el siguiente orden:

- Subida-stop-bajada-stop (por defecto)
- Subida-bajada (para dos botones independientes)
- Subida-bajada con “hombre presente” (para dos botones independientes)

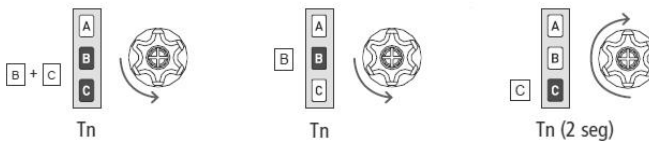

*Tn: Emisor ya memorizado*

▪ **GESTIÓN SUPER SENSIBILIDAD EN LA DETECCIÓN DE OBSTÁCULOS EN BAJADA**

Si fuese necesario, se puede activar/desactivar una sensibilidad muy elevada en la detección de obstáculos en bajada.

- Activar la función

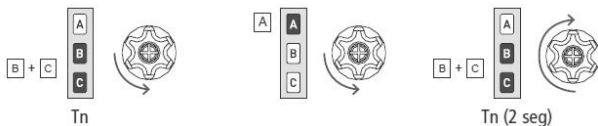

- Desactivar la función

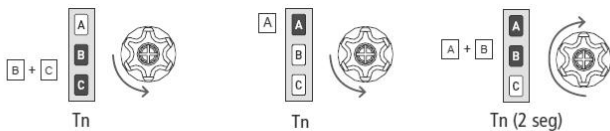

*Tn: Emisor ya memorizado*

## MANTENIMIENTO

Para un buen uso y una mayor durabilidad, se recomienda la realización de mantenimientos y revisiones periódicas, como mínimo una vez al año, o con más frecuencia en función de la fatiga del viento en el lugar de instalación. Para prevenir la corrosión se recomienda la limpieza periódica de canalones y perfiles con jabón neutro. La frecuencia mínima es de una vez al año, debiendo aumentarse para los perfiles expuestos a ambientes agresivos (marinos, industriales, presencia de polvo en suspensión, etc.). Es importante aclarar abundantemente con agua, tras el uso de detergentes, para evitar la formación de sales sobre la superficie de los perfiles. Esta limpieza periódica, adecuadamente realizada, elimina de la superficie de los perfiles los agentes exógenos que pueden atacar el recubrimiento y el aluminio, alargando la vida de los perfiles y sus prestaciones estéticas. Para la limpieza de la lona se recomienda la eliminación del polvo acumulado en seco, para poder quitar todas las partículas de la superficie por aspiración, insuflación de aire, apaleo o cepillado. En caso de eliminación de manchas de dedos o grasa usar agua con jabón neutro. Si son manchas acuosas limpiar con una esponja, como máximo, y frotar con un paño húmedo. No utilizar NUNCA detergentes ni otros productos químicos. Por último, se ha de tener en cuenta la revisión del apriete de tornillos, según los pares de apriete.

Las operaciones de instalación y puesta en marcha, de ajuste y de mantenimiento obligatorio deberán ser realizadas por técnicos especializados.

Todas las operaciones se realizarán en condiciones de seguridad, después de haber cortado la alimentación eléctrica del sistema.

Es conveniente desplazar el producto periódicamente (extensión completa y recogida completa) y comprobar que funcionan correctamente los componentes. No dejar el producto parado durante mucho tiempo.

## LONA

La limpieza de la lona se requiere para proteger a la misma de la formación de moho y retrasar la suciedad permanente. Por ello, recomendamos:

- Al menos dos veces al año inspeccionar su estado.
- Si fuera necesario limpiar con un aspirador y con una esponja o paño húmedo, usando agua tibia y productos no agresivos como jabón neutro.

Para la limpieza en condiciones de seguridad, extienda el toldo, desconecte la alimentación eléctrica y limpie la parte del tejido a la vista. Siga las instrucciones y en caso de duda póngase en contacto con su distribuidor.

## DESMONTAJE Y ELIMINACIÓN

El desmontaje del producto al final de su vida útil deberá ser realizado por personal cualificado, con todas las características de seguridad observadas en la instalación.

Para desmontar este producto, se efectuarán los pasos a la inversa que se realizaron para su montaje, adoptando una serie de medidas de precaución. Para ampliar la información sobre estas instrucciones de desmontaje, le remitimos a los capítulos sobre instalación de este manual, que contienen dibujos e información detallada.

Le aconsejamos que recicle el embalaje del producto de forma responsable:

- Clasifique los desechos separando todos y cada uno de los distintos materiales para proceder a una efectiva eliminación del embalaje.
- No elimine los materiales de embalaje junto con residuos de otro tipo. Llévelos a un punto de recogida de materiales de embalaje designado por las autoridades locales.
- Con el fin de reducir al mínimo el impacto ambiental de los envases y residuos de envases, es necesario definir la composición y naturaleza del embalaje de nuestros productos para recomendar la mejor eliminación de los mismos.

- **Papel y cartón:** En la gestión de residuos, el reciclaje de papel y cartón adquiere un gran protagonismo, ya que se logra recuperar hasta un 70%. La eliminación de papel y cartón puede realizarse por varios cauces como la recogida por los operadores privados, o entrega en plantas de tratamiento de residuos.
- **Plástico:** El reciclaje de plásticos supone muchas ventajas para el medioambiente y por ende, beneficios en la calidad de vida de todos, contribuyendo a un gran ahorro de materia prima, recursos naturales, energéticos y económicos. La eliminación del plástico puede realizarse mediante operadores privados o la entrega en plantas de tratamiento de residuos.
- **Film alveolar:** Está compuesto de polietileno de baja densidad, lo que lo convierten en un material 100 % reciclable. Para su óptima eliminación entregar los residuos de este material en plantas de tratamiento de residuos plásticos.
- **Equipos eléctricos, electrónicos y equipos AEE:** no deben eliminarse mezclados con otro tipo de residuos. Pueden ser entregados en los centros específicos para ello, regulados por las administraciones locales.
- **Textil:** El aprovechamiento de los residuos textiles resulta indispensable cuando hablamos de reciclaje. La reutilización ayuda a reducir el consumo de agua y los gases que se liberan en el proceso de fabricación. Para favorecer la adecuada eliminación de los textiles, se recomienda depositarlos en un centro de residuos especializado donde procederán a la separación de las distintas fibras textiles.

Actúe siguiendo las recomendaciones para un eficaz reciclaje de los productos. Recuerde que reciclar es más que una acción, es el valor de la responsabilidad por preservar los recursos naturales.

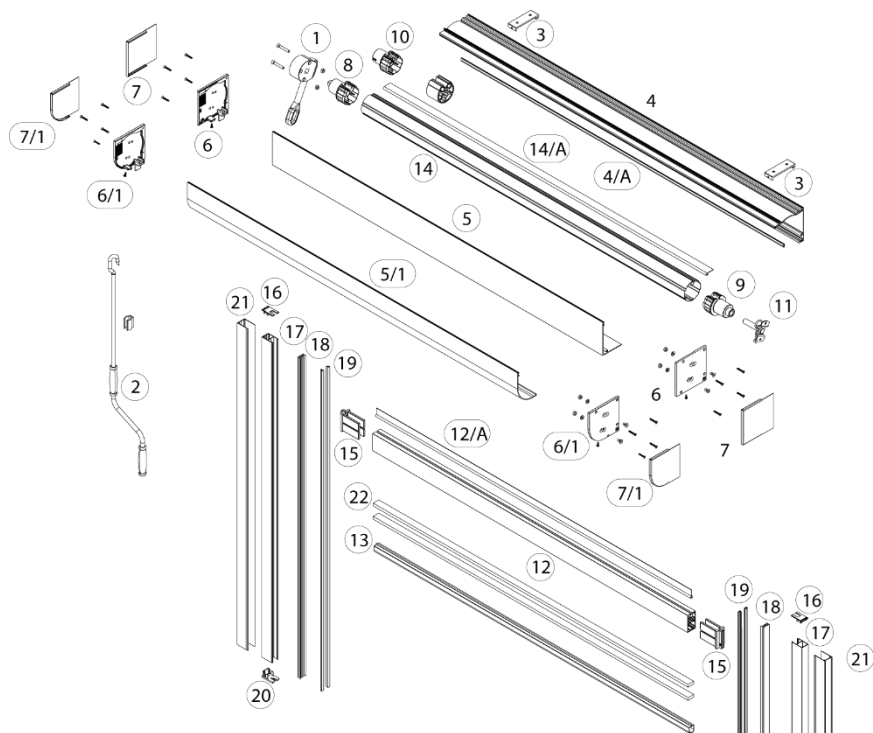

- |     |                            |      |                   |
|-----|----------------------------|------|-------------------|
| 1   | Máquina reductora          | 12   | Terminal          |
| 2   | Manivela                   | 12/A | Macarrón terminal |
| 3   | Soporte cajón              | 13   | Burlete           |
| 4   | Ángulo superior            | 14   | Eje               |
| 5   | Tapa cajón Ágora           | 14/A | Macarrón eje      |
| 5/1 | Tapa cajón Aura            | 15   | Tapón terminal    |
| 6   | Testero Ágora              | 16   | Embudo para guía  |
| 6/1 | Testero Aura               | 17   | Guía              |
| 7   | Embellecedor testero Ágora | 18   | Guía interior ZIP |
| 7/1 | Embellecedor testero Aura  | 19   | Guía exterior ZIP |
| 8   | Casquillo                  | 20   | Pie enganche guía |
| 9   | Casquillo hueco            | 21   | Guía compensadora |
| 10  | Casquillo motor            | 22   | Pletina terminal  |
| 11  | Placa H30 eje extraíble    |      |                   |

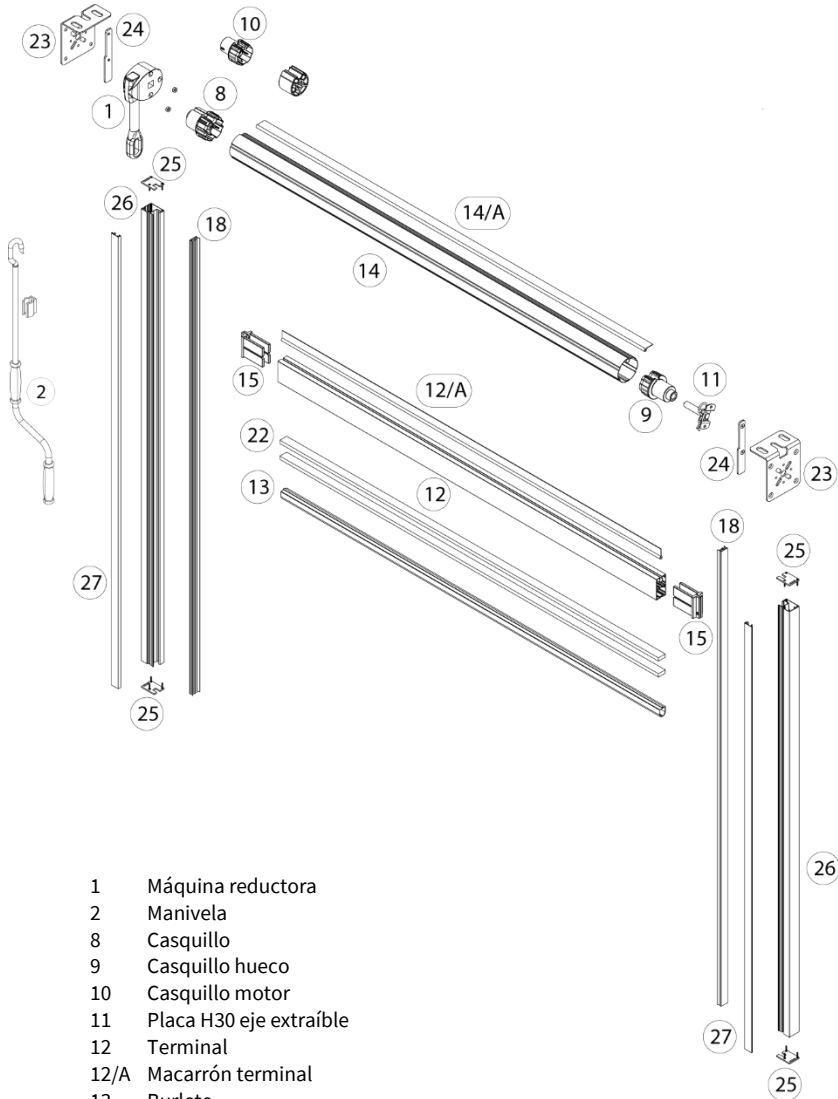

- |      |                         |    |               |
|------|-------------------------|----|---------------|
| 1    | Máquina reductora       | 24 | Perno         |
| 2    | Manivela                | 25 | Embudo guía   |
| 8    | Casquillo               | 26 | Guía          |
| 9    | Casquillo hueco         | 27 | Cubierta guía |
| 10   | Casquillo motor         |    |               |
| 11   | Placa H30 eje extraíble |    |               |
| 12   | Terminal                |    |               |
| 12/A | Macarrón terminal       |    |               |
| 13   | Burlete                 |    |               |
| 14   | Eje                     |    |               |
| 14/A | Macarrón eje            |    |               |
| 15   | Tapón terminal          |    |               |
| 18   | Guía interior ZIP       |    |               |
| 22   | Pletina terminal        |    |               |
| 23   | Soporte Nuvola          |    |               |

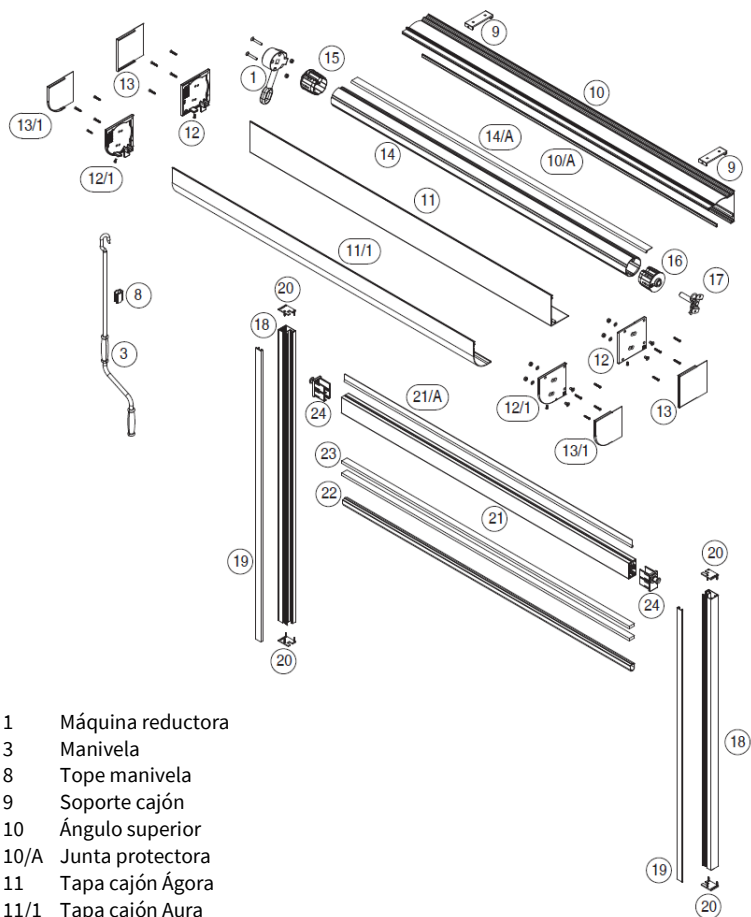

- |      |                            |      |                   |
|------|----------------------------|------|-------------------|
| 1    | Máquina reductora          | 18   | Guía              |
| 3    | Manivela                   | 19   | Cubierta guía     |
| 8    | Tope manivela              | 20   | Pie guía          |
| 9    | Soporte cajón              | 21   | Terminal          |
| 10   | Ángulo superior            | 21/A | Macarrón terminal |
| 10/A | Junta protectora           | 22   | Burlete           |
| 11   | Tapa cajón Ágora           | 23   | Pletina           |
| 11/1 | Tapa cajón Aura            | 24   | Tapón terminal    |
| 12   | Testero Ágora              |      |                   |
| 12/1 | Testero Aura               |      |                   |
| 13   | Embellecedor testero Ágora |      |                   |
| 13/1 | Embellecedor testero Aura  |      |                   |
| 14   | Eje                        |      |                   |
| 14/A | Macarrón eje               |      |                   |
| 15   | Casquillo con eje 13x20    |      |                   |
| 16   | Casquillo hueco Ø14        |      |                   |
| 17   | Placa H30 eje extraíble    |      |                   |



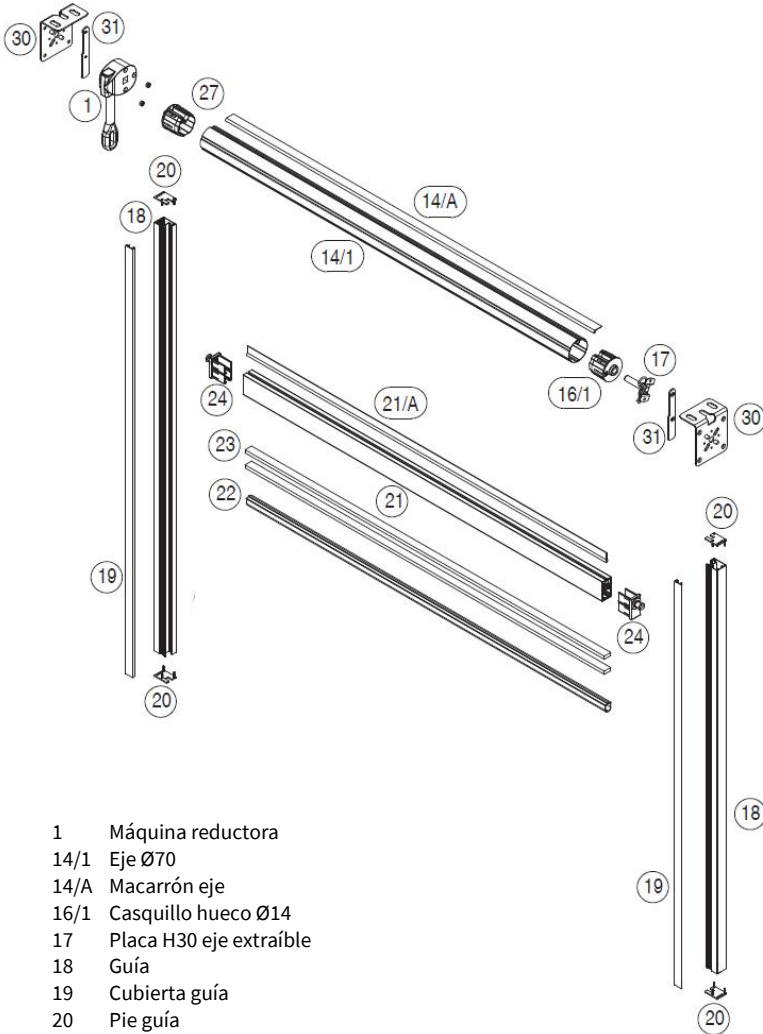

- 1 Máquina reductora
- 14/1 Eje Ø70
- 14/A Macarrón eje
- 16/1 Casquillo hueco Ø14
- 17 Placa H30 eje extraíble
- 18 Guía
- 19 Cubierta guía
- 20 Pie guía
- 21 Terminal
- 21/A Macarrón terminal
- 22 Burlete
- 23 Pletina
- 24 Tapón terminal

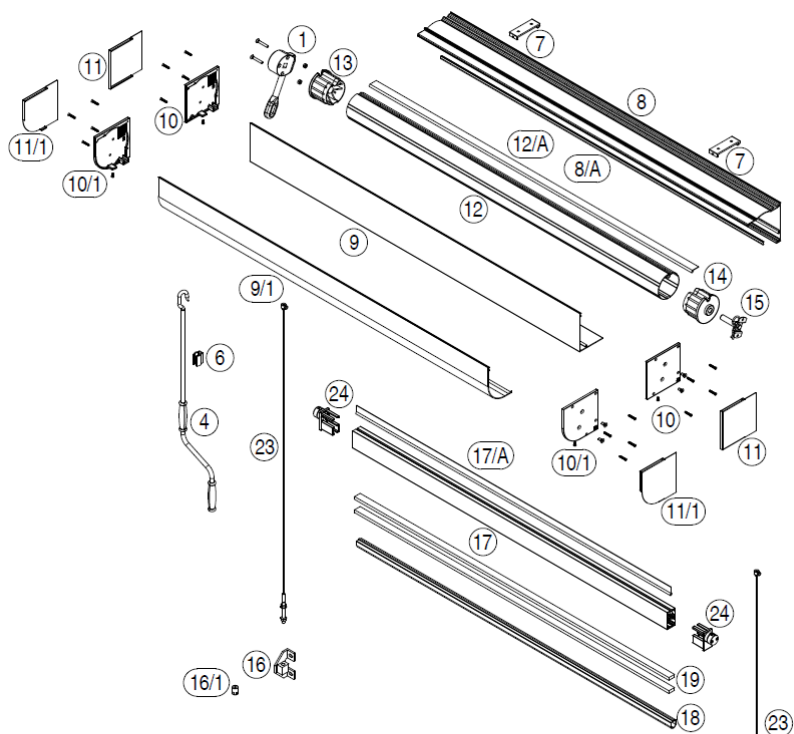

- 1 Máquina reductora
- 4 Manivela
- 6 Tope manivela
- 7 Soporte cajón
- 8 Ángulo superior
- 8/A Junta protectora
- 9 Tapa Ágora
- 9/1 Tapa Aura
- 10 Testero Ágora
- 10/1 Testero Aura
- 11 Embellecedor testero Ágora
- 11/1 Embellecedor testero Aura
- 12 Eje
- 12/A Macarrón eje
- 13 Casquillo con eje 13x20
- 14 Casquillo hueco Ø14
- 15 Placa H30 eje extraíble

- 16 Soporte varilla/cable
- 16/1 Soporte cable inox
- 17 Terminal
- 17/A Macarrón terminal
- 18 Burlete
- 19 Pletina
- 23 Cable inox Ø4 mm
- 24 Tapón terminal

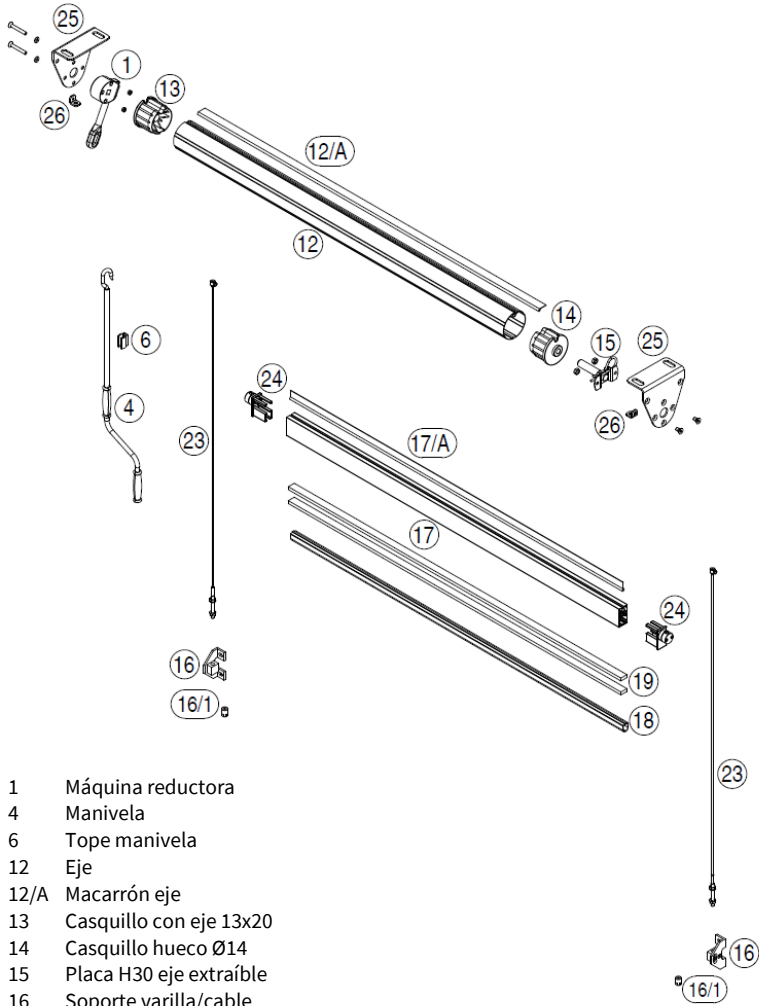

- 1 Máquina reductora
- 4 Manivela
- 6 Tope manivela
- 12 Eje
- 12/A Macarrón eje
- 13 Casquillo con eje 13x20
- 14 Casquillo hueco Ø14
- 15 Placa H30 eje extraíble
- 16 Soporte varilla/cable
- 16/1 Soporte cable inox
- 17 Terminal
- 17/A Macarrón terminal
- 18 Burlete
- 19 Pletina
- 23 Cable inox Ø4 mm
- 24 Tapón terminal
- 25 Soporte Nuvola cable/varilla
- 26 Soporte varilla/cable

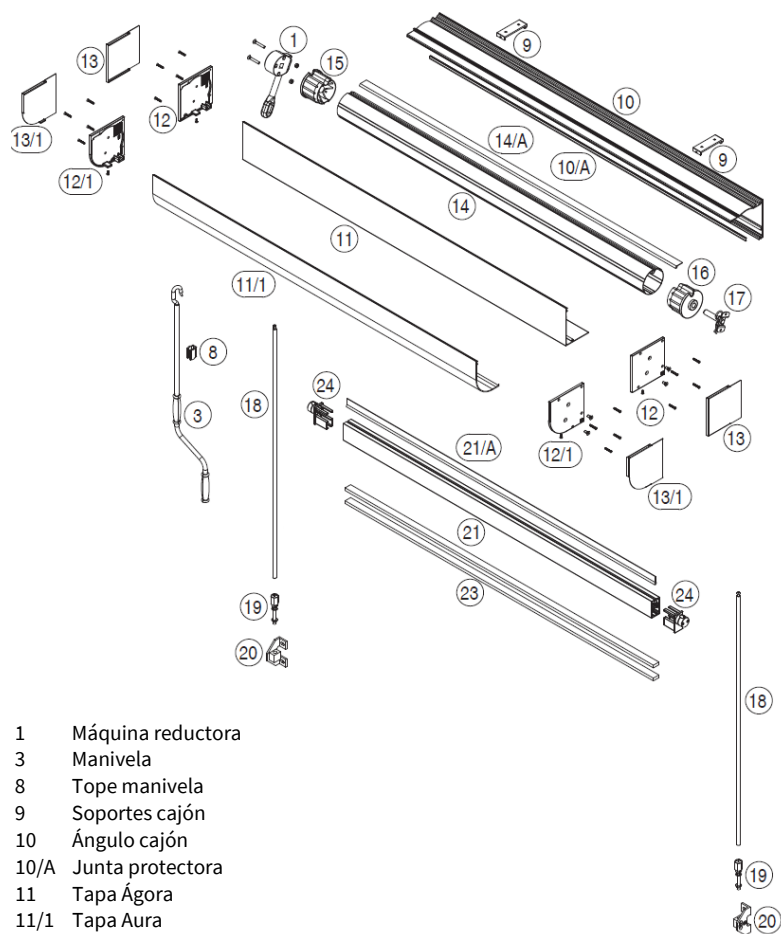





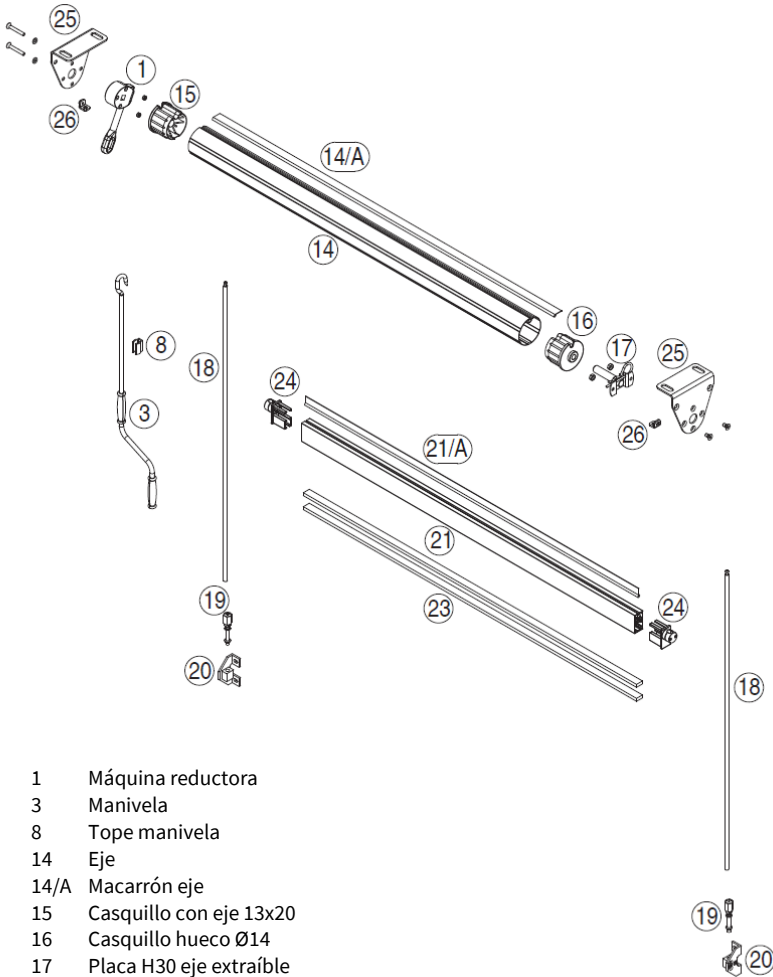











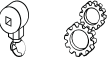

- 1 Máquina reductora
- 3 Manivela
- 8 Tope manivela
- 9 Soportes cajón
- 10 Ángulo cajón
- 10/A Junta protectora
- 11 Tapa Ágora
- 11/1 Tapa Aura
- 12 Testero Ágora
- 12/1 Testero Aura
- 13 Embellecedor testero Ágora
- 13/1 Embellecedor testero Aura
- 14 Eje
- 14/A Macarrón eje
- 15 Casquillo con eje 13x20
- 16 Casquillo hueco Ø14
- 17 Placa H30 eje extraíble

- 18 Varilla inox Ø10 mm
- 19 Tensor para varilla
- 20 Soporte varilla/cable
- 21 Terminal
- 21/A Macarrón terminal
- 23 Pletina
- 24 Tapón terminal



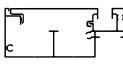
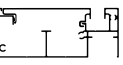

















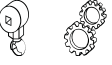



- 1 Máquina reductora
- 3 Manivela
- 8 Tope manivela
- 14 Eje
- 14/A Macarrón eje
- 15 Casquillo con eje 13x20
- 16 Casquillo hueco Ø14
- 17 Placa H30 eje extraíble
- 18 Varilla inox Ø10 mm
- 19 Tensor varilla inox
- 20 Soporte varilla/cable
- 21 Terminal
- 21/A Macarrón terminal
- 23 Pletina
- 24 Tapón terminal
- 25 Soporte Nuvola
- 26 Soporte varilla/cable



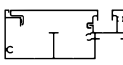
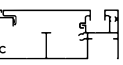















### ÁGORA

Tamaños	110				130				
Sistema									
Automatismo									
Compatibilidad guías		-				-			
(Anclaje)									
		-				-			
									
									
									

### AURA

Tamaños	110				130				150
Sistema									
Automatismo									
Compatibilidad guías		-				-			
(Anclaje)									
		-				-			
									
									
									

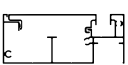
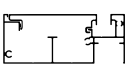
## NUVOLA

Tamaños	110				130			
Sistema								
Automatismo								
Compatibilidad guías			-				-	
(Anclaje)								
								
								

	ZIP		Guise		Cable		Vánila		Manual		Motorizado		Techo		Pared		Autoportante
---	-----	---	-------	---	-------	---	--------	---	--------	---	------------	---	-------	---	-------	---	--------------

## PROBLEMAS, CAUSAS Y SOLUCIONES

PROBLEMAS	CAUSAS	SOLUCIONES
La tela se desplaza hacia un lado	Toldo mal nivelado	Nivelar correctamente
El terminal no baja	Protección térmica del motor	Colocar las guías correctamente
El motor no funciona tras varios minutos de funcionamiento continuo	Protección térmica del motor	Dejar enfriar el motor durante algunos minutos
El motor es muy ruidoso	Avería del motor	Se requiere intervención técnica
El motor no se mueve	Error de cableado	Comprobar el circuito eléctrico con los diagramas
	Avería del motor	Comprobar el motor y reemplazarlo si es necesario



## INTRODUCTION

Advance information  
Caution notice  
Liability  
User and installer requirements

---

## INSTALLATION AND STARTUP PROCEDURE

Installation  
Startup procedure  
Power operation and automation  
Maintenance / Disassembly and disposal

---

## DISASSEMBLY CHART COMBINATIONS

---

## TROUBLESHOOTING

---

## ADVANCE INFORMATION



### **This manual shall not be modified.**

It is intended for installers, maintenance staff, owners and users of the vertical drop system (hereinafter referred to as *awning*) as an essential element to ensure correct usage and maintenance of the product. All instructions concerning handling, unpacking, installation and startup, adjustments and maintenance are intended solely for installers. Any sections concerning correct usage and maintenance, as well as the guarantee, are intended for owner.

This usage manual is an integral part of the product and essential for the guarantee validity. Please keep all sections stored in an easily accessible location to ensure that it is always available for review by qualified staff in charge of the product's installation, maintenance or adjustment to maintain the required records.

### CAUTION NOTICE

- Please read all instructions included in this manual carefully.
- Before installation, please check that the awning is in perfect conditions.
- You must also ensure that the location where it is due to be installed meets all safety measures.
- Installation must only be carried out by qualified staff.
- The manufacturer shall not be liable for any damages caused by product misuse or arising from poor installation.
- This product complies with the *EN 13561 standard for awnings. Feature requirements including safety and those established by EN 1932 External blinds and shutters. Wind load resistance. Testing method and features criteria.* Dispatched from the factory in perfect conditions.
- Please ensure that you have the correct tools and equipment for installation such as gloves, eye protection and safety footwear.
- If the model includes an electric motor, please read all manufacturer instructions carefully before installing.

## LIABILITY

Manufacturers shall not be liable for any damages caused to individuals or the installation itself due to non compliance with the instructions included herein regarding installation, usage and maintenance. Also in case of acts of violence or incorrect operation and/or modifications undertaken without written authorisation.

When carrying out maintenance or repair works, you must use only genuine spare parts. This product is guaranteed pursuant to any agreements established at the time of purchase. For that reason, the guarantee and CE marking shall not be deemed valid in cases where the guidelines and instructions for usage provided in this manual have not been followed.

## USER AND INSTALLER REQUIREMENTS

These systems are exclusively intended for the use that they were designed for. Any other type of use shall be deemed as misuse and therefore hazardous. Under no circumstances should any faulty products be installed in order to prevent damages to the installation itself and to prevent any hazardous situations.

**Installation must always be carried out by professional installers. In the event of any queries or if you intend to use the product for any other purposes than those stated, please contact LaViuda prior to its installation.**

# AURA / ÁGORA ZIP

## SHUTTER BOX INSTALLATION

Check the shutter box assembly and insert the internal guide rails into the end cap trims ensuring that these are flush.

Place into position:

- (A) Indoor recess mounted.
- (B) Outdoor façade mounted.
- (C) Self standing.

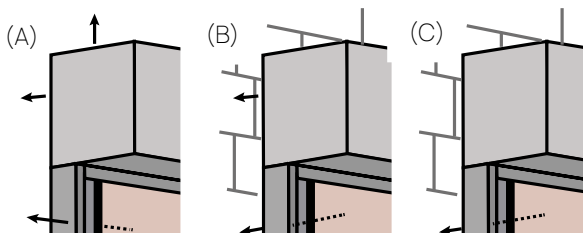
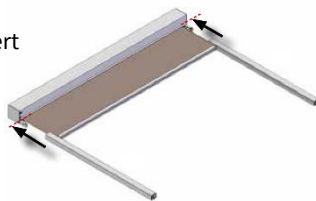

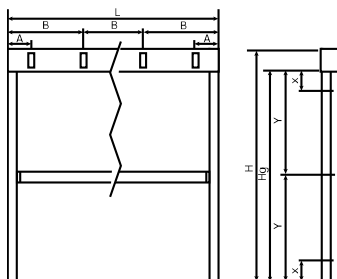

## INSTALLATION OF SHUTTER BOX WITH SUPPORTS

It shall depend on whether the unit is to be wall or ceiling mounted, and must be done according to the installation diagram and using the recommended attachment methods.



(INSTALLATION DIAGRAM)







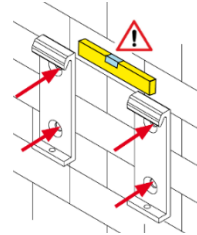





L		A	B	H		X	Y
supports				attachment holes			
0-1500	2	150	-	0-1000	2	90	-
1501-3000	3	150	L/2	1001-2000	3	90	Hg / 2
3001-4000	4	150	L/3	2001-2500	4	90	Hg / 3
4001-5000	5	150	L/4	3001-4000	5	90	Hg/4
5001-6500	6	150	L/5	4001-5000	6	90	Hg/5
6501-8000	7	150	L/6	5001-6000	7	90	Hg/6

RECOMMENDED ATTACHMENT METHODS		
HSL-3-SK		CONCRETE
Hilti HRD-U10 Hilti HRD-S10		CONCRETE PERFORATED BRICKWORK SOLID BRICKWORK
HUD-1 HUD-L		

*In the case of corrosive environments, we recommend using stainless steel attachment hooks*

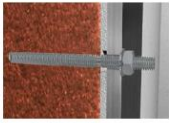

## Step by step instructions to install the attachment hooks:

MECHANICAL BONDING		CHEMICAL BONDING	
	1 Drill a hole using the adequate bit for your attachment type.		1 Drill a hole using the adequate bit for your attachment type.
	2 Please ensure that the hole is deep enough when drilling.		2 Please ensure that the hole is deep enough when drilling.
	3 Remove any resulting dust and particles from the hole (ideally using compressed air).		3 Brush off any dust and particles from the hole.
	4 Install the attachment hooks.		4 Remove any remaining dust using compressed air.
	5 Fasten them up to the recommended tightening torque (check the Hilti catalogue for further information).		5 Apply the chemical adhesive.
	6 Final setup.		6 Insert and adjust the attachment hooks observing the required waiting time before placing the plate (check product packaging for instructions).
			7 Put the place into position and fasten it up to the recommended tightening torque (check the Hilti catalogue).

ATTACHMENT  
INSTALLATION

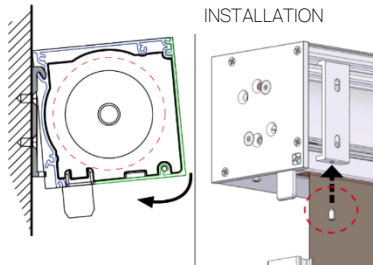

**Wall mounted:** Position the shutterbox in its intended location and attach it through the rear.

**Ceiling mounted:** remove the lid in order to gain access to the support. Place the shutterbox on top of the support tabs and fix it using the support's grub screw located on top of the profile.

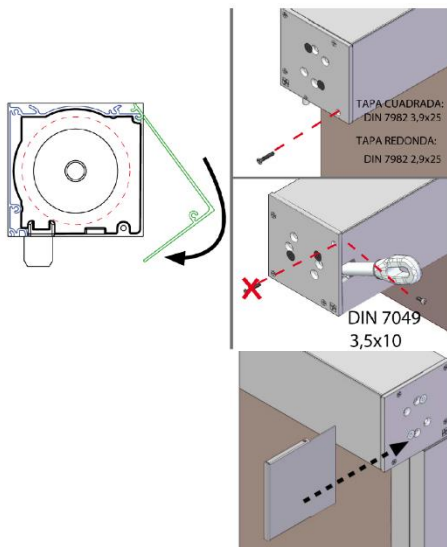
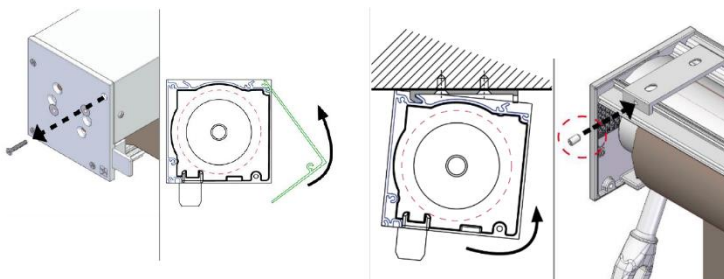

\*When installing inside an indoor recess, the cover must be attached from the inside and not the lateral to ensure that it can be accessed when needed.

Slide the cover lids over the lateral end caps (where applicable).

## GUIDE RAIL INSTALLATION

Insert the lids into the guide rails and attach them with the DIN 7982 3,5 x 25mm bolts. Insert the guide rails ensuring that these are flush with the end caps.

Place into position (indoor recess, outdoor façade or built-in as the case may be) following the installation diagram above.

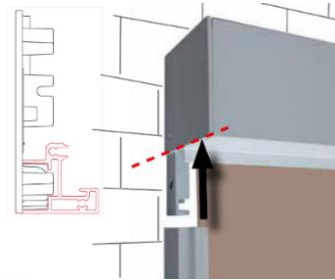

After placing the guide rails, lower the awning as much as possible and check that these are level before closing the awning and attach the guide rails.

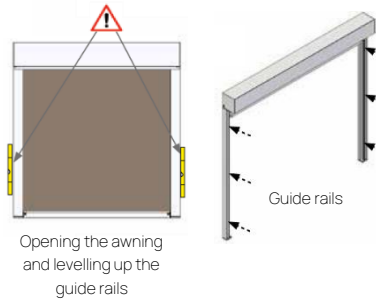

Tighten up the guide rails using the DIN 7981 M3,9 x16mm bolts according to the following position:

INDOOR RECESS

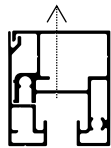

Simple guide rail

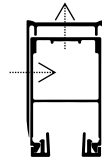

Adjustment guide rail

OUTDOOR FAÇADE

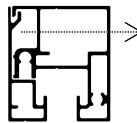

Simple guide rail

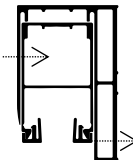

Adjustment guide

BUILT IN

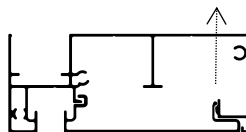

MB Guide rail



Place the awning on the upper section and insert the internal ZIP guide rail inside the fabric's fastener.

Once installed, insert the guide rail cover (A) by applying pressure.

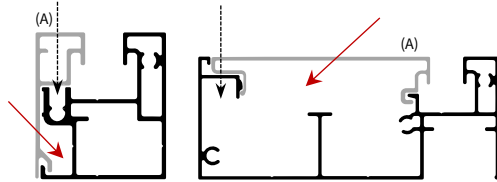

For the **compensating guide rail:**



Attach the compensating guide (lodging-guide rail profil) and the box. The lower part of the lateral end cap must fit into the profile.

Insert the guide rail profil into the lodging-guide rail.





Zip must be inserted inside the internal rail profile. It is very important to verify this point.

Once the fabric is inserted, put down the clothing to the lower point.

During its descending movement, the profile relocates by itself.

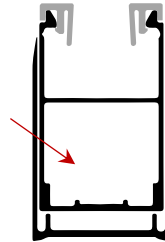

Once it is relocated, it is necessary to fix the guide rail profile to the lodging-guide rail profile with screws, which they will be exposed in the flat part.

## AWNING ADJUSTMENT

Adjust the motor limit switches if required. Lift and lower the fabric several times as far as it will go to ensure that it is adequately positioned for a correct operation.

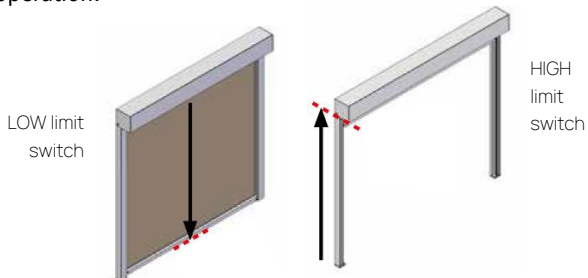

**When extending the canvas, you may find creases or marks caused by remaining rolled up for long periods of time. However, this should NOT be an issue since these marks will disappear once stabilised over time due to the outdoor weather conditions.**

# NUVOLA

## ZIP

### ATTACHING THE END CAPS

Join the bolts to the end caps and place them into position. Insert the internal guide rails ensuring that these are flush.

Attach as per mount type:

- (A) Indoor recess mounted
- (B) Outdoor façade mounted
- (C) Self standing.

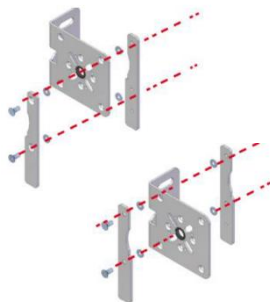

### RECOMMENDED ATTACHMENT METHODS

HSL-3-SK		CONCRETE
Hilti HRD-U10 Hilti HRD-S10		CONCRETE PERFORATED BRICKWORK SOLID BRICKWORK
HUD-1 HUD-L		

*In the case of corrosive environments, we recommend using stainless steel attachment hooks*

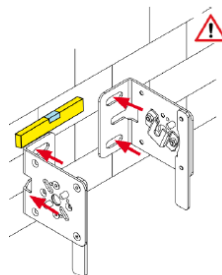

\* See attachment system sequence on page 7

Insert the cylinder and its seal on the available axle side and place the end caps. Insert the bolt grips on the motor's head and the available side in order to attach it.

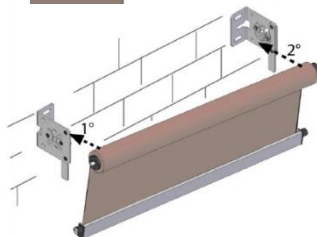
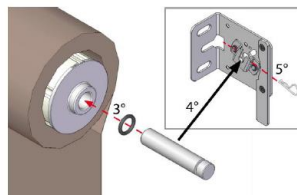

## GUIDE RAIL INSTALLATION

Insert the lids into the guide rails and attach them with the DIN 7982 3,5 x 25mm bolts. Insert the guide rails through the bolts ensuring that they are level.

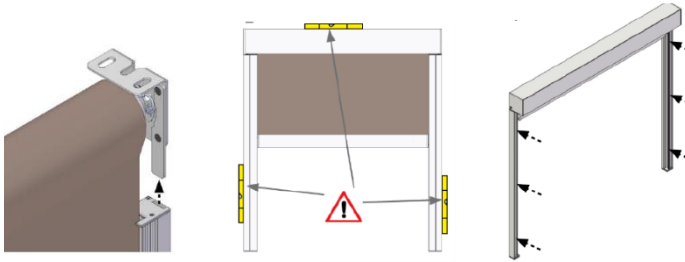

Place into position (indoor recess, outdoor façade or built-in as the case may be) following the installation diagram above. Tighten up the guide rails using the DIN 7981 M3,9 x16mm bolts according to the following position:

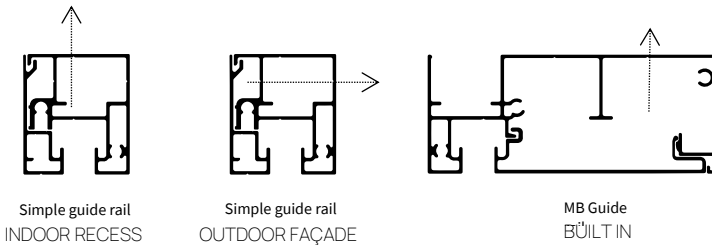

Once the guide rails have been secured into position, insert the internal ZIP guides ensuring that the fastener remains inside.

Close the entire assemblage using the guide rail cover.

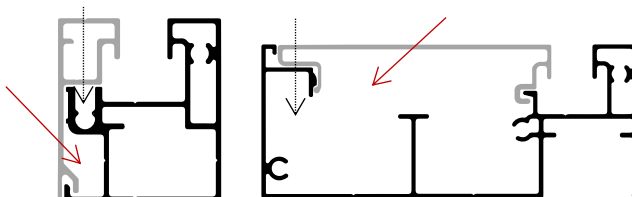

### AWNING ADJUSTMENT

Adjust the motor limit switches if required. Lift and lower the fabric several times as far as it will go to ensure that it is adequately positioned for a correct operation.

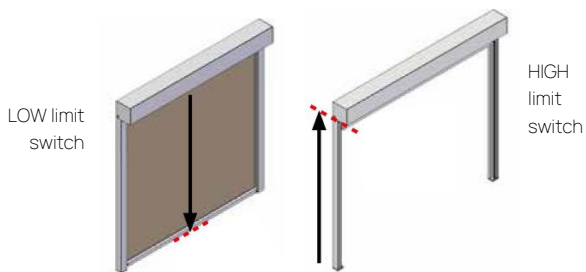

**When extending the canvas, you may find creases or marks caused by remaining rolled up for long periods of time. However, this should NOT be an issue since these marks will disappear once stabilised over time due to the outdoor weather conditions.**

## AURA / ÁGORA GUIDE

### SHUTTER BOX INSTALLATION

Place the end caps into position and insert the internal guide rails ensuring that these are flush. Attach as per mount type:

- (A) Indoor recess mounted.
- (B) Outdoor façade mounted.
- (C) Self standing.

### INSTALLATION OF SHUTTER BOX WITH SUPPORTS

As an optional feature, you may use brackets to support the shutter box. In that case, these must be placed and attached ensuring that they are level.

(INSTALLATION DIAGRAM)

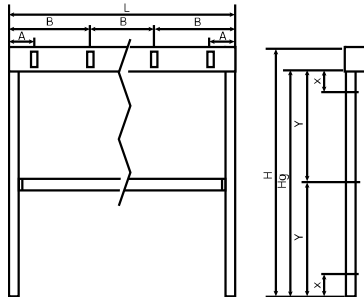

L supports	A	B	H attachment holes	X	Y		
0-1500	2	150	-	0-1000	2	90	-
1501-3000	3	150	L/2	1001-2000	3	90	Hg / 2
3001-4000	4	150	L/3	2001-3000	4	90	Hg / 3
4001-5000	5	150	L/4	3001-4000	5	90	Hg / 4
			4001-5000	6	90	Hg / 5	

### RECOMMENDED ATTACHMENT METHODS

HSL-3-SK		CONCRETE
Hilti HRD-U10 Hilti HRD-S10		CONCRETE PERFORATED BRICKWORK SOLID BRICKWORK
HUD-1 HUD-L		

*In the case of corrosive environments, we recommend using stainless steel attachment hooks*

*\*See attachment system sequence on page 7*

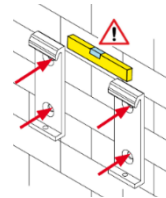

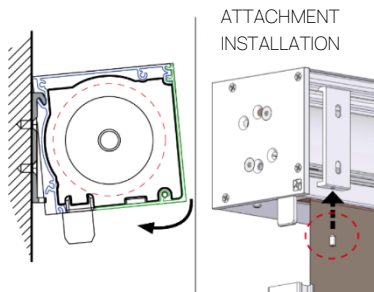

ATTACHMENT  
INSTALLATION

**Wall mounted:** position the shutterbox in its intended location and attach it through the rear.

**Ceiling mounted:** remove the lid in order to gain access to the support. Place the shutterbox on top of the support tabs and fix it using the support's grub screw located on top of the profile.

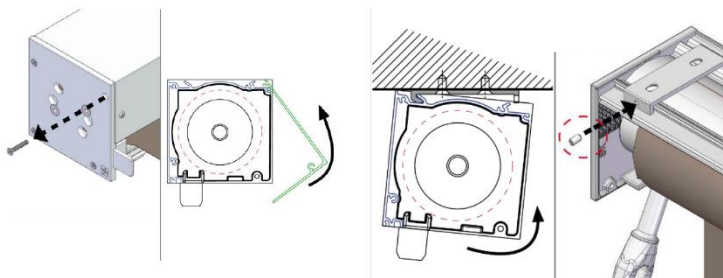

GUIDE RAIL INSTALLATION

Insert the lids into the guide rails and attach them with the DIN 7982 3,5 x 25mm bolts. Insert the guide rails through the end cap trim bolts ensuring that they are level.

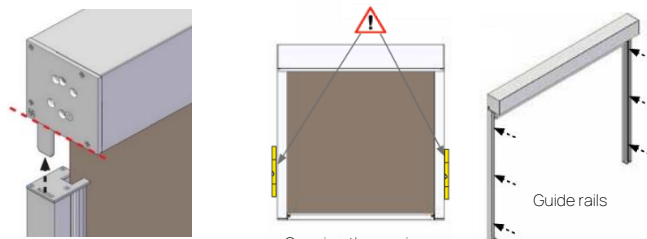

Opening the awning  
and levelling up the  
guide rails

Guide rails

Place into position (indoor recess, outdoor façade or built-in as the case may be) following the installation diagram above. Tighten up the guide rails using the DIN 7981 M3,9 x16mm bolts.

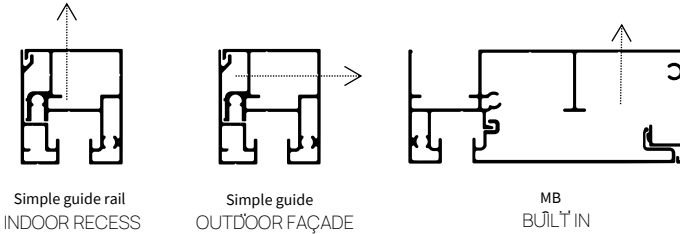

## AWNING ADJUSTMENT

Adjust the motor limit switches if required. Lift and lower the fabric several times as far as it will go to ensure that it is adequately positioned for a correct operation.

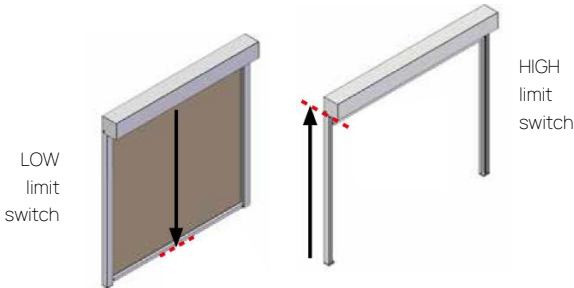

**When extending the canvas, you may find creases or marks caused by remaining rolled up for long periods of time. However, this should NOT be an issue since these marks will disappear once stabilised over time due to the outdoor weather conditions.**

# NUVOLA GUIDE

## ATTACHING THE END CAPS

Join the bolts to the end caps and place them into position. Insert the internal guide rails ensuring that these are flush.

Attach as per mount type:

- (A) Indoor recess mounted.
- (B) Outdoor façade mounted.
- (C) Self standing.

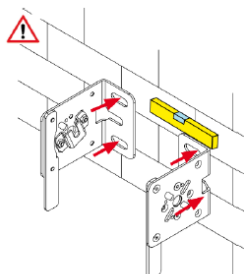

### RECOMMENDED ATTACHMENT METHODS

HSL-3-SK		CONCRETE
Hilti HRD-U10 Hilti HRD-S10		CONCRETE PERFORATED BRICKWORK SOLID BRICKWORK
HUD-1 HUD-L		

*In the case of corrosive environments, we recommend using stainless steel attachment hooks*

*\* See attachment system sequence on page 7*

Insert the cylinder and its seal on the available axle side.

Position the axle on the end caps. Insert the bolt grips on the motor's head and the available side in order to attach it.

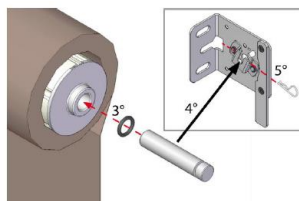
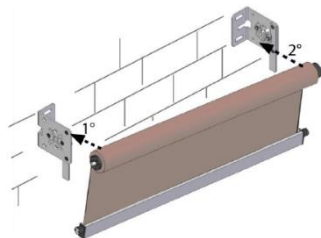



## GUIDE RAIL INSTALLATION

Insert the lids into the guide rails and attach them with the DIN 7982 3,5 x 25mm bolts. Insert the guide rails through the end cap trim bolts ensuring that they are level. Place into position (indoor recess, outdoor façade or built-in as the case may be) following the installation diagram above. Tighten up the guide rails using the DIN 7981 M 3,9 x16mm bolts.

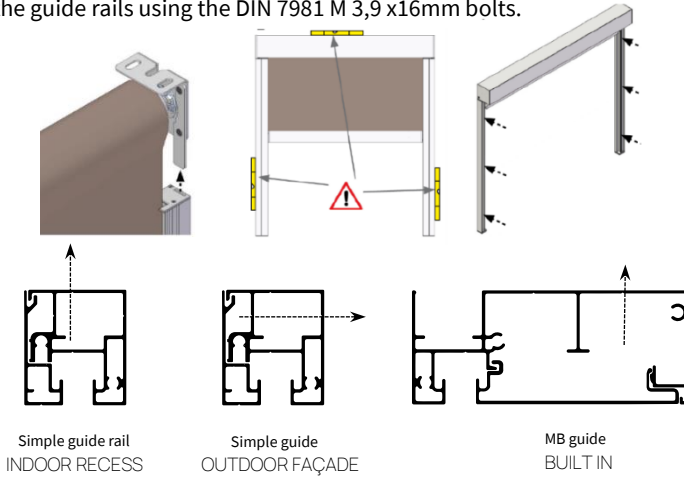

Simple guide rail  
INDOOR RECESS

Simple guide  
OUTDOOR FAÇADE

MB guide  
BUILT IN

## AWNING ADJUSTMENT

Adjust the motor limit switches if required. Lift and lower the fabric several times as far as it will go to ensure that it is adequately positioned for a correct operation.

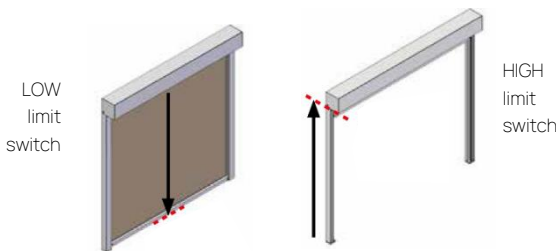

**When extending the canvas, you may find creases or marks caused by remaining rolled up for long periods of time. However, this should NOT be an issue since these marks will disappear once stabilised over time due to the outdoor weather conditions.**

# AURA / ÁGORA CABLE

## SHUTTER BOX INSTALLATION

Position the end cap trims in their intended location and attach as per mount type:

- (A) Indoor recess mounted.
- (B) Outdoor façade mounted.

## INSTALLATION OF SHUTTER BOX WITH SUPPORTS

As an optional feature, you may use brackets to support the shutter box. In that case, these must be placed and attached ensuring that they are level.

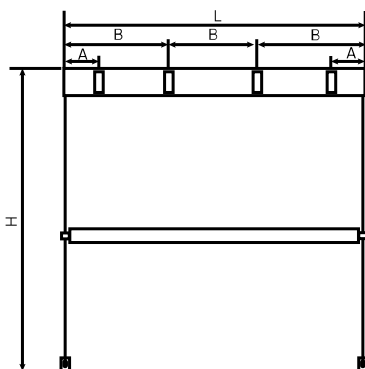
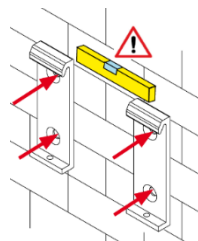

(INSTALLATION DIAGRAM)

L	supports	A	B
0-1500	2	150	- B
1501-3000	3	150	L/2
3001-4000	4	150	L/3
4001-5000	5	150	L/4
4001-5000	5	150	L/4

RECOMMENDED ATTACHMENT METHODS		
HSL-3-SK		CONCRETE
Hilti HRD-U10 Hilti HRD-S10		CONCRETE PERFORATED BRICKWORK SOLID BRICKWORK
HUD-1 HUD-L		

*In the case of corrosive environments, we recommend using stainless steel attachment hooks*

**\*See attachment system sequence on page 7**

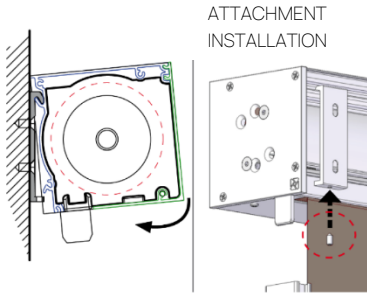

ATTACHMENT  
INSTALLATION

**Wall mounted:** position the shutterbox in its intended location and attach it through the rear.

**Ceiling mounted:** remove the lid in order to gain access to the support. Place the shutterbox on top of the support tabs and fix it using the support's grub screw located on top of the profile.

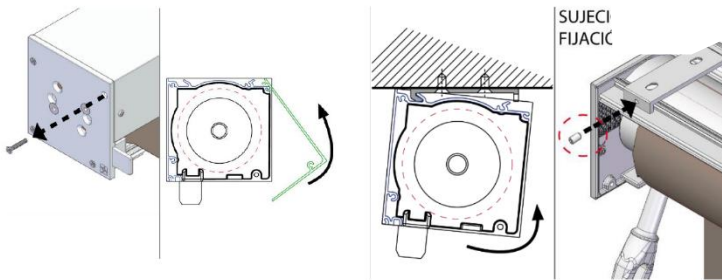

## CABLE ATTACHMENT

Place the cable according to the following diagram. Attach to the end cap, the end slat and the support.

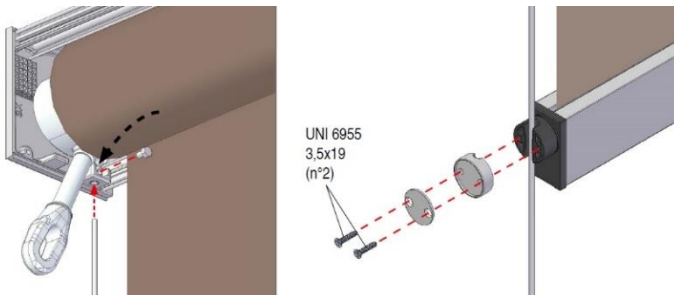

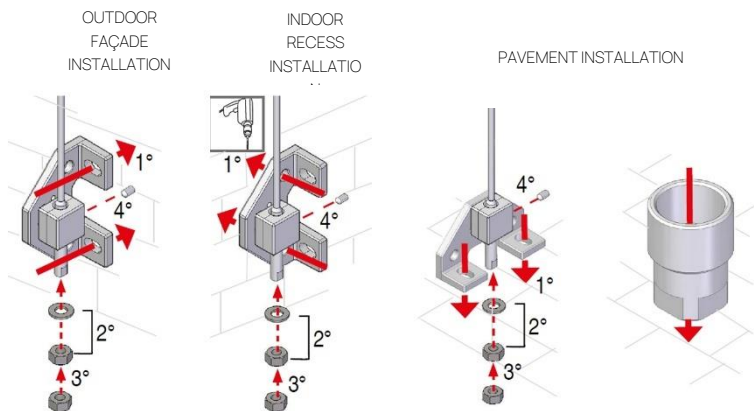

### AWNING ADJUSTMENT

Adjust the motor limit switches if required. Lift and lower the fabric several times as far as it will go to ensure that it is adequately positioned for a correct operation.

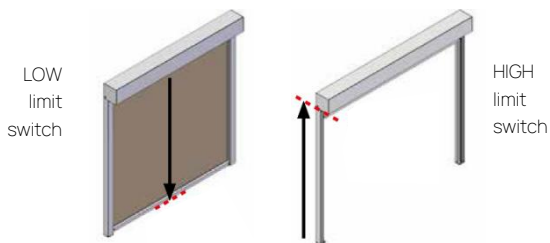

**When extending the canvas, you may find creases or marks caused by remaining rolled up for long periods of time. However, this should NOT be an issue since these marks will disappear once stabilised over time due to the outdoor weather conditions.**

## NUVOLA CABLE

### ATTACHING THE END CAPS

Join the bolts to the end caps and place them into position. Insert the internal guide rails ensuring that these are flush Attach as per mount type:

- (A) Indoor recess mounted
- (B) Outdoor façade mounted.

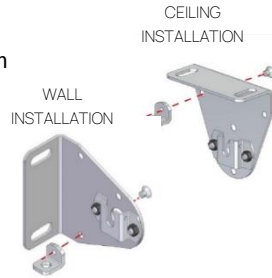

### RECOMMENDED ATTACHMENT METHODS

HSL-3-SK		CONCRETE
Hilti HRD-U10 Hilti HRD-S10		CONCRETE PERFORATED BRICKWORK SOLID BRICKWORK
HUD-1 HUD-L		

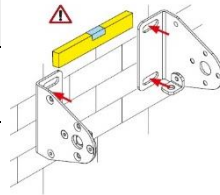

*In the case of corrosive environments, we recommend using stainless steel attachment hooks*

\* See attachment system sequence on page 7

Insert the cylinder and its seal on the available axle side.

Position the axle on the end caps. Insert the bolt grips on the motor's head and the available side in order to attach it.

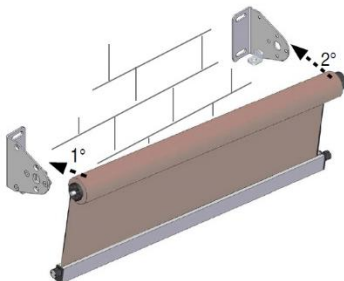
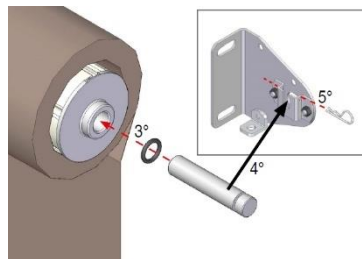

### CABLE ATTACHMENT

Place the cable according to the following diagram. Attach to the end cap, the end slat and the support.

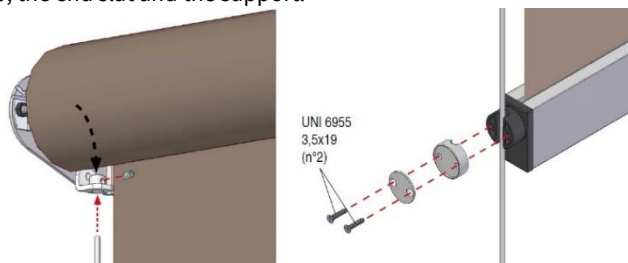

OUTDOOR FAÇADE

INDOOR FAÇADE

PAVEMENT

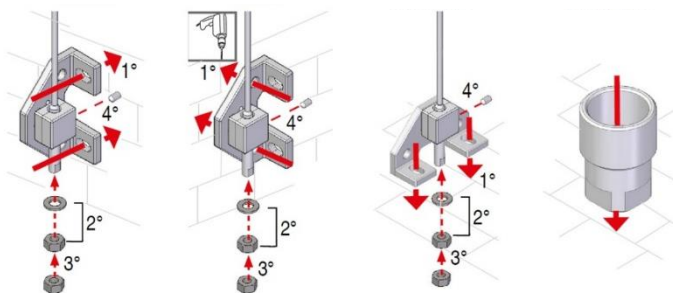

### AWNING ADJUSTMENT

Adjust the motor limit switches if required. Lift and lower the fabric several times as far as it will go to ensure that it is adequately positioned for a correct operation.

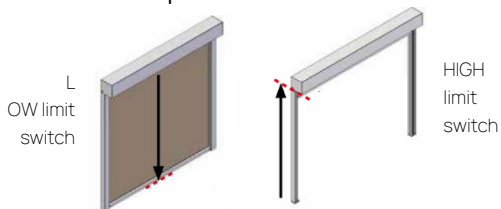

**When extending the canvas, you may find creases or marks caused by remaining rolled up for long periods of time. However, this should NOT be an issue since these marks will disappear once stabilised over time due to the outdoor weather conditions.**

## AURA / ÁGORA ROD SYSTEM

### SHUTTER BOX INSTALLATION

Position the end cap trims in their intended location and attach as per mount type:

- (A) Indoor recess mounted.
- (B) Outdoor façade mounted.

### INSTALLATION OF SHUTTER BOX WITH SUPPORTS

As an optional feature, you may use brackets to support the shutter box. In that case, these must be placed and attached ensuring that they are level.

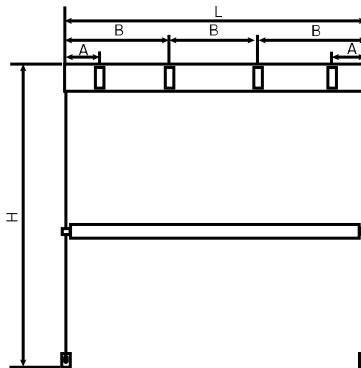
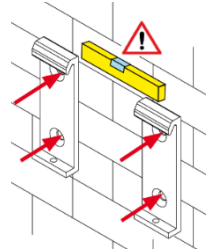

(INSTALLATION DIAGRAM)

L	supports	A	B
0-1400	2	150	B
1501-3000	3	150	L/2
3001-4000 1501-3000	4	150	L/3
4001-5000 3001-4000	5	150	L/4
4001-5000	5	150	L/4

### RECOMMENDED ATTACHMENT METHODS

HSL-3-SK		CONCRETE
Hilti HRD-U10 Hilti HRD-S10		CONCRETE PERFORATED BRICKWORK SOLID BRICKWORK
HUD-1 HUD-L		

*En entornos corrosivos, se recomienda utilizar anclajes de acero inoxidable*

*\* See attachment system sequence on page 7*

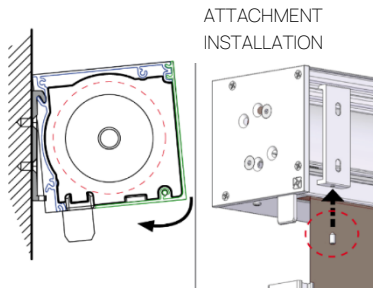

**Wall mounted:** position the shutterbox in its intended location and attach it through the rear.

**Ceiling mounted:** remove the lid in order to gain access to the support. Place the shutterbox on top of the support tabs and fix it using the support's grub screw located on top of the profile.

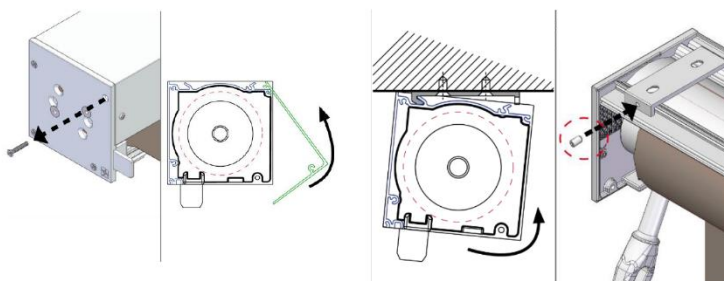

### ROD ATTACHMENT

Place the rod according to the following diagram. Attach to the end cap, the end slat and the support.

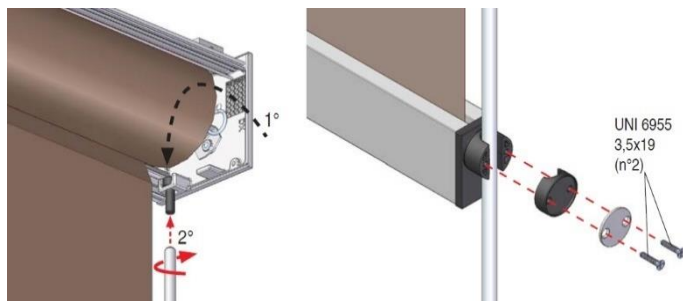



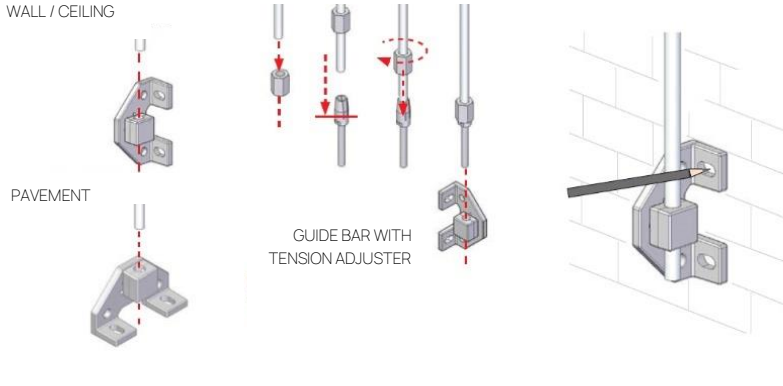

## AWNING ADJUSTMENT

Adjust the motor limit switches if required. Lift and lower the fabric several times as far as it will go to ensure that it is adequately positioned for a correct operation.

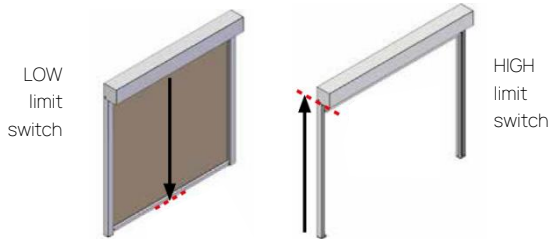

**When extending the canvas, you may find creases or marks caused by remaining rolled up for long periods of time. However, this should NOT be an issue since these marks will disappear once stabilised over time due to the outdoor weather conditions.**

# NUVOLA ROD SYSTEM



## ATTACHING THE END CAPS

Join the bolts to the end caps and place them into position. Insert the internal guide rails ensuring that these are flush.

Attach as per mount type:

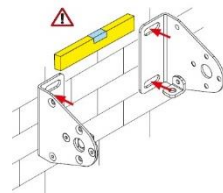
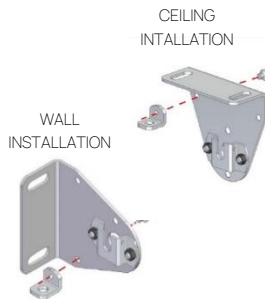
- (A) Indoor recess mounted.
- (B) Outdoor façade mounted.



RECOMMENDED ATTACHMENT METHODS		
HSL-3-SK		CONCRETE
Hilti HRD-U10 Hilti HRD-S10		CONCRETE PERFORATED BRICKWORK SOLID BRICKWORK
HUD-1 HUD-L		CONCRETE PERFORATED BRICKWORK SOLID BRICKWORK
<i>In the case of corrosive environments, we recommend using stainless steel attachment hooks</i>		

*\*See attachment system sequence on page 7*

Insert the cylinder and its seal on the available axle side.

Position the axle on the end caps. Insert the bolt grips on the motor's head and the available side in order to attach it.

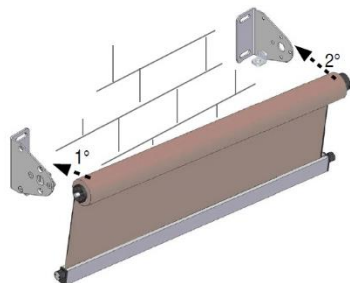
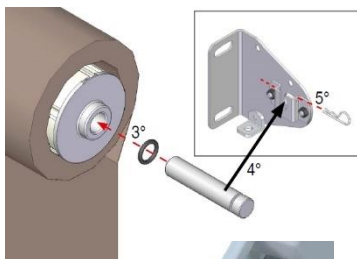

## ROD ATTACHMENT

Place the rod according to the following diagram. Attach to the end cap, the end slat and the support.

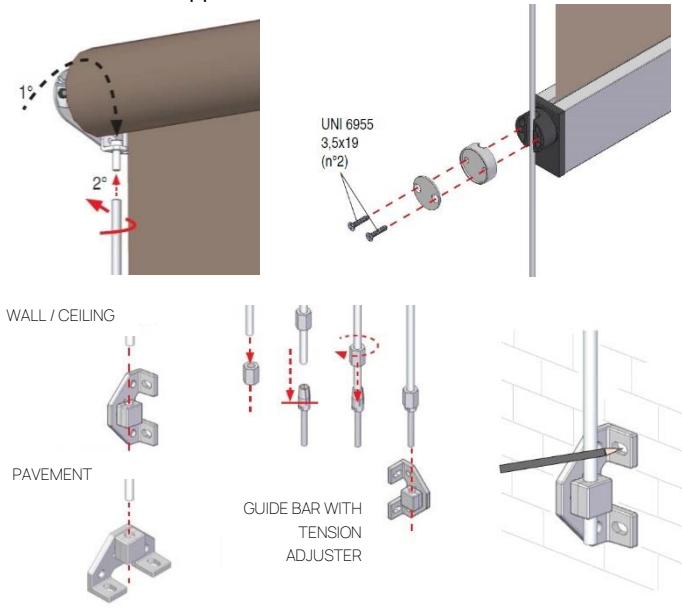

## AWNING ADJUSTMENT

Adjust the motor limit switches if required. Lift and lower the fabric several times as far as it will go to ensure that it is adequately positioned for a correct operation.

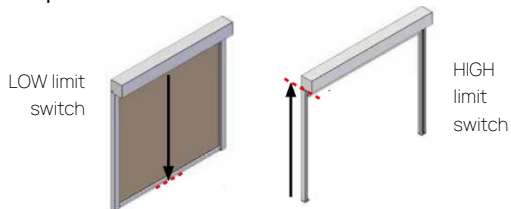

**When extending the canvas, you may find creases or marks caused by remaining rolled up for long periods of time. However, this should NOT be an issue since these marks will disappear once stabilised over time due to the outdoor weather conditions.**

## MOTOR

### INSTALLATION

Please ensure that the Senso RX motor by Cherubini is installed by a home automation and motorisation professional only and provide them with a copy of this guide.

In addition, the installer must comply with all current regulations and legislation in force in the country where the installation is carried out and must inform its customers regarding the product usage and maintenance conditions. Using the application established by Cherubini for any other purpose shall be considered misuse. Please note that the above circumstances, in addition to non compliance with any instructions included herein, shall result in Cherubini refusing any liability and invalidating the product guarantee.

### ELECTRICAL SUPPLY

In order to avoid malfunction or hazardous situations, all electrical control components connected to the motor must be designed in accordance with the motor's own electrical features.

- Device disconnection from the mains supply must be carried out in conformity with national installation regulations.
- If using outdoors, please use a H05RN-F power supply wire with a minimum 2% carbon content.
- If not used, the white wire must remain isolated at all times. Please do not touch the white wire when the motor is connected to the mains supply.
- Switch installation is optional, and it must be connected to either the Live (brown) or Neutral (blue) wire. When using the switch, the motor shall work on a step by step mode (up, stop, down, stop, etc.).

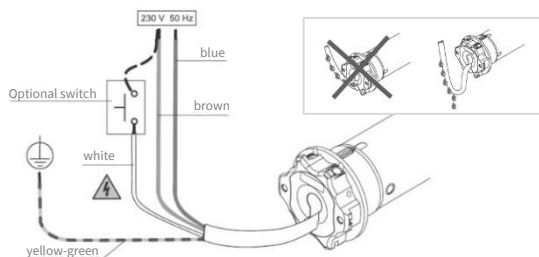

## STARTUP PROCEDURE

### (IV) Accessing the remote control unit's settings menu

In order to prevent any accidental motor setup modifications during use, the settings menu is automatically disabled 8 hours after the last sequence.

- OPENING / CLOSING IN POP PLUS / POP LUX / POP PLUX / SKIPPER PLUS / SKIPPER LUX / SKIPPER PLUX CONTROL UNITS

- Check function status:

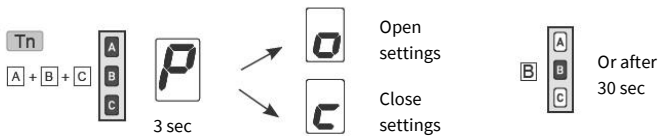

- Enable settings:

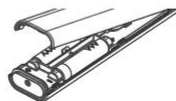
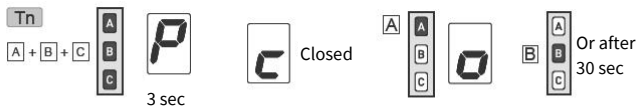

Remove and place batteries

- Disable settings:

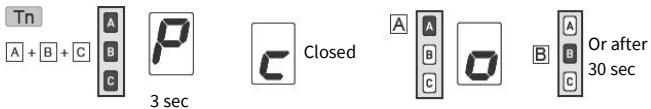

- **OPENING/ CLOSING IN SKIPPER / GIRO SERIES / POP CONTROL UNITS**
  - Check function status:

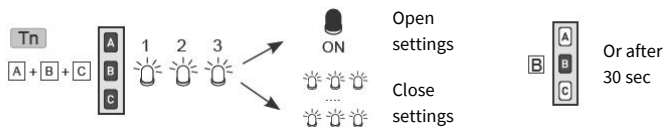

- Enable settings:

OPTION 1

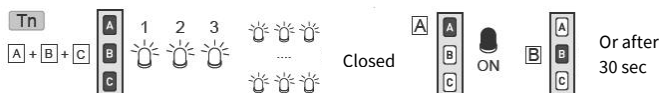

OPTION 2

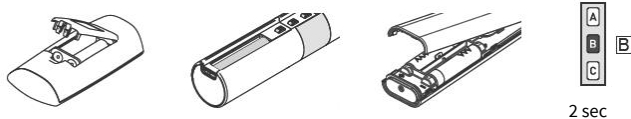

- Disable settings:



- **MEMORISING FIRST REMOTE CONTROL UNIT**

This operation is undertaken when a new motor is used for the first time or after a full motor memory reset. In order to avoid any interference, please make sure that only one motor is connected to the mains supply during this stage.

All buttons must be pressed as described in the sequence below and within 4 seconds between one step and the next. Otherwise, the command will be rejected and you will have to start over again.

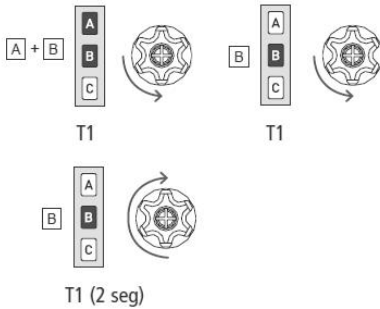

- Press A+B simultaneously. Then press B. In both cases, the motor will undertake a short rotation in either direction at the end.
- Press B for 2 sec. The motor will undertake a long rotation in the opposite direction to validate the command.

Following are two examples of incomplete sequences:

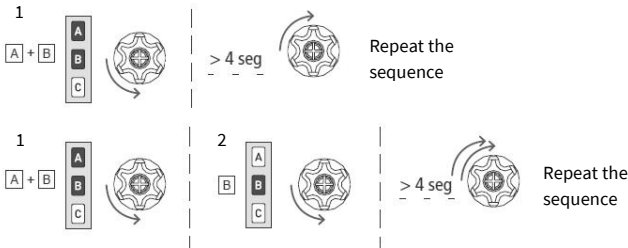

Every time you connect the motor to the mains supply, you will have three hours to memorise the first control unit. After this period, the option to memorise the first control unit will be disabled, and you will need to disconnect and reconnect to the mains in order to reset it.

▪ MEMORISING FURTHER REMOTE CONTROL UNITS

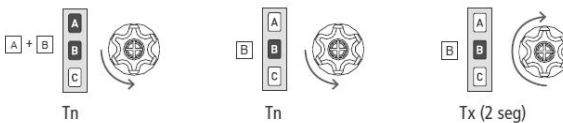

*Tn: RCU already memorised*

*Tx: RCU to be memorised*

▪ REMOTE CONTROL UNIT CANCELLATION

You may cancel each memorised control unit individually. After cancelling the last one, the motor shall return to the initial default setting.

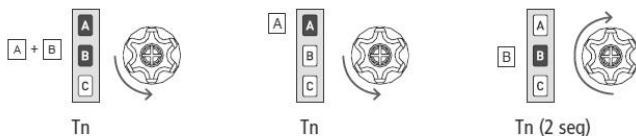

Tn: RCU already memorised

▪ CANCELLATION OF ALL REMOTE CONTROL UNITS

- From the RCU itself:

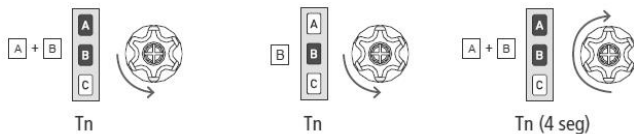

Tn: RCU already memorised

- From the auxiliary cable (use only in case of emergency):

1. Disconnect from the mains using the automatic switch.
2. Join the white and brown (live) or blue (neutral) cables together.
3. Reconnect the motor to the mains.
4. Disconnect the motor's power supply again (4 seconds).
5. Reconnect the motor to the mains again after 4 sec. and it will undertake a small rotation followed by a longer rotation in the opposite direction.
6. Disconnect the motor's power supply.
7. Separate the white wire from the brown or blue wire. Isolate the white wire adequately before reconnecting the motor to the mains supply.

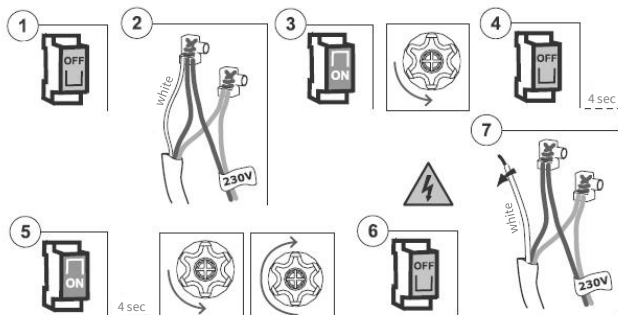



## (V) Limit switch adjustment

### ▪ CLOSING LIMIT SWITCH REGULATION

- Retract the awning to the closed position.
- Maintain the "STOP" button pressed until the motor undertakes a downward rotation.

If the awning is fully closed:

- Lower the awning a further 20cm. You may need to use the up button to do this, as the correct rotation direction will only be established after memorising the closing position.
- Establish the correct position by pressing "STOP" until the motor undertakes a downward rotation.

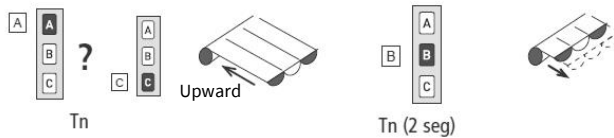

*Tn: RCU already memorised*

### ▪ OPENING LIMIT SWITCH REGULATION

- Lift the awning to the opening position by maintaining the down button pressed in the control unit.
- Maintain the position by pressing "STOP" for 2 seconds until the motor undertakes an upward rotation.

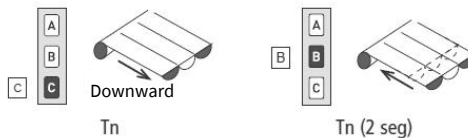

*Tn: RCU already memorised*

■ CLOSING LIMIT SWITCH CANCELLATION

Continue with the following sequence and proceed to adjust the closing limit switch again:

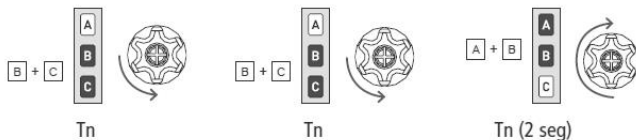

*Tn: RCU already memorised*

■ OPENING LIMIT SWITCH CANCELLATION

Follow the sequence below and proceed to adjust the opening limit switch again:

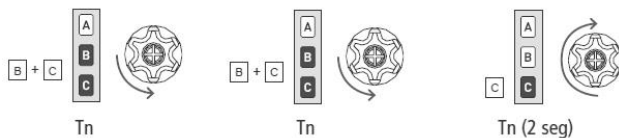

*Tn: RCU already memorised*

■ CANCELLATIO OF ALL LIMIT SWITCHES

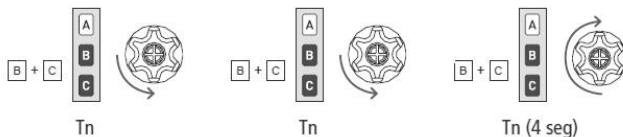

*Tn: RCU already memorised*

## (I) Advanced features

### ▪ INTERMEDIATE POSITION

- Memorising the intermediate position:
  - Place the awning in your favourite position.
  - Press the "STOP" button for 4 seconds until the motor confirmation takes place.
  - Once memorised, you can return the awning to this position by pressing "STOP" for 2 seconds.

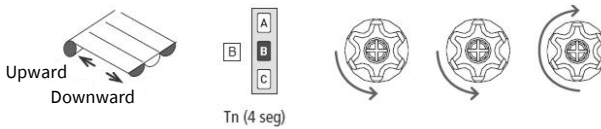

*Tn: RCU already memorised*

- Additional intermediate position:
  - A convenient position to make the awning open automatically using the WindTec Lux sensor.
  - In order to adjust this position, you must first memorise both limit switches before attempting the following sequence.

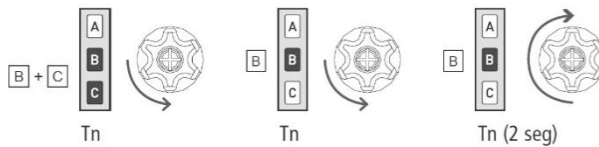

*Tn: RCU already memorised*

- The motor will now be in the manual operation mode and should allow you to execute this command accurately.
- Move the awning to your desired opening position.
- Press the B button for 2 seconds until the motor confirmation takes place.

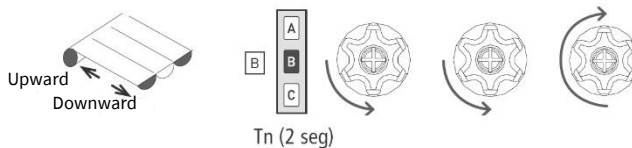

- When the opening motion is activated by WindTec Lux sensor's light automation, the awning will be placed in the additional intermediate position.

- *Cancelling the intermediate position:*
  - o You may cancel it if you are not interested in using this function or to modify the memorised position.
  - o BEFORE CANCELLING, return the awning to this intermediate position by pressing "STOP" for 2 seconds.
  - o Press the "STOP" button for 4 seconds until the motor confirmation signal takes place.

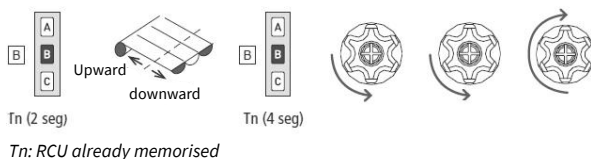

▪ **CLOSING STRENGTH ADJUSTMENT**

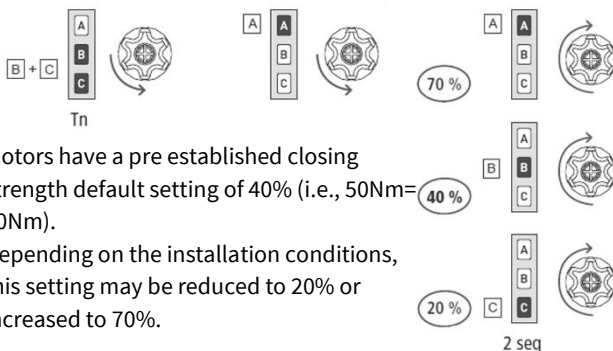

- CANVAS STRETCHING POSITION

When enabling this function, the motor will automatically return to the established extension to stretch the canvas as much as possible once the opening position has been reached. This position must therefore be setup after memorising both limit switches.

- How to start the optional position memorisation procedure:  
This sequence allows you to achieve an extremely accurate tension adjustment, since it will bring the awning to its maximum opening position in order to prepare the motor for manual operation mode.

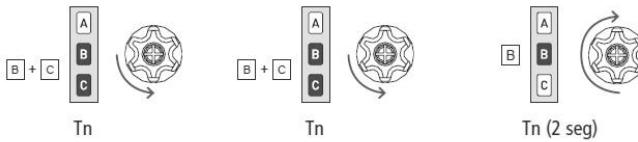

*Tn: RCU already memorised*

- Adjustment and validation of optional position:  
After adjusting and confirming this position, the awning will move to its maximum opening position before returning to the new position.

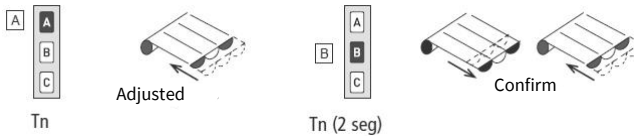

*Tn: RCU already memorised*

- Deleting the optional position:

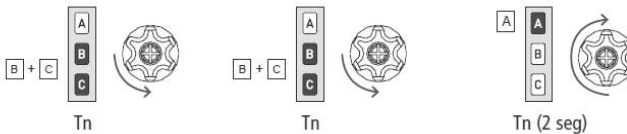

*Tn: RCU already memorised*

■ CONTROL UNIT MODE MANAGEMENT

There are three types of setup available. In order to change the setup type, you must repeat the sequence until you reach the desired option. These are available in the following order:

- Up-stop-down-stop (default).
- Up-down (for two independent buttons).
- Up-down with manual operation mode (for two independent buttons).

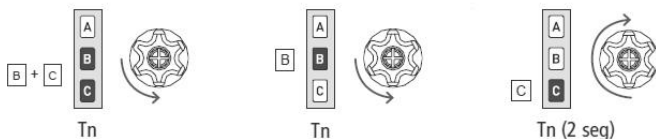

*Tn: RCU already memorised*

■ HIGHLY SENSITIVE DOWNWARD OBSTACLE DETECTION MANAGEMENT

If required, you may enable/ disable the high sensitivity downward obstacle detection setting.

- Enabling the function:

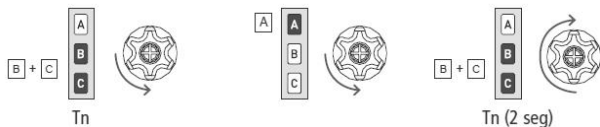

- Disabling the function:

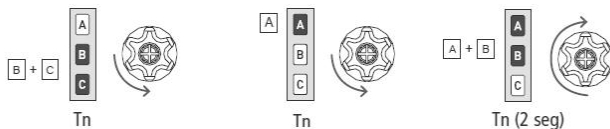

*Tn: RCU already*

## MAINTENANCE

In order to ensure good operation and longer durability, we recommend undertaking regular maintenance and checks at least on a yearly basis, or more frequently depending on wind strength at the installation location. To prevent rust, we recommend cleaning all gutters and slats regularly with neutral soap. This should be done at least on a yearly basis, or more often in the case of slats exposed to harsh weather conditions (such as marine, industrial, suspended dust environments, etc.). It is also important to rinse with abundant water after using any detergents to prevent the accumulation of salt on the profile slats. When done correctly, this regular cleaning will remove any external agents from the slats that may damage its coating or the aluminium material itself, thereby extending the slat's life and its cosmetic appearance. When cleaning the canvas fabric, we recommend removing any accumulated dust while dry to ensure that all particles are either vacuum cleaned or using an air compressor, brush or by beating the fabric. To remove fingerprints or grease marks, use water with neutral soap. In the event of liquid stains, dab these with a sponge before rubbing them off with a wet cloth. DO NOT use any detergents or chemicals. Lastly, you must also remember to retighten the bolts during the regular checks according to the tightening torque.

Any installation and setup, adjustment and compulsory maintenance jobs must be carried out by specialist technicians only.

All jobs shall be undertaken under adequate safety conditions and after disconnecting the unit's power supply.

We recommend moving the unit regularly (fully extending and fully retracting) in order to check that all components are working correctly. Do not leave the unit immobile for long periods of time.

## CANVAS

Canvas fabrics must be cleaned in order to protect these from mould and delaying their permanent soiling. For that reason, we recommend:

- Checking its condition at least twice per year.
- If required, vacuum cleaning or wiping using a wet sponge or cloth dipped in lukewarm water and non aggressive cleaning products such as neutral soap.

In order to clean in adequately safe conditions, extend the awning completely and disconnect from the power supply before cleaning all fabric areas that remain visible. Please follow the above instructions and, in case of any queries, please contact your retailer.

## DISASSEMBLY AND DISPOSAL

At the end of its useful life, the product should only be disassembled by qualified professionals observing all the safety guidelines used for its installation.

When disassembling the product, you must follow the same steps taken for its initial assembly in the reverse order, in addition to adopting a number of precautionary measures. For further information regarding the disassembly instruction, please read the installation section included with this manual which contains several drawings and detailed information.

We recommend recycling the product's packaging in a responsible manner:

- All waste must be segregated among the different types of material so that they can be disposed of effectively.
- Please do not dispose of packaging materials alongside other types of waste. These must be transported to the packaging collection point designated by your local authorities.
- Below is a detailed breakdown of the composition and origins of our product's packaging to allow for their correct disposal with the aim of reducing the environmental impact of all our packing materials and containers.



- **Paper and cardboard:** Paper and cardboard recycling has a leading role in the waste management process as it is possible to recover up to 70% of the material. You may dispose of these materials via different methods, such as private collection or transporting them to waste treatment plants.
- **Plastic:** Plastic recycling results in many advantages for the environment, thereby providing great benefits for our community's living standards while contributing to save raw materials as well as natural, energy and financial resources. You may dispose of these materials by using private collection or transporting them to waste treatment plants.
- **Bubble wrap:** Made from low density polyethylene, this material is therefore 100% recyclable. In order to ensure its correct disposal, please transport these to any plastic waste treatment plant.
- **Electrical, electronic and EEE equipment:** must not be disposed of alongside other types of waste. These may be transported to specific disposal centres managed by your local authorities.
- **Textiles:** Making the most of textile waste is indispensable when it comes to recycling. By reusing these fabrics, we contribute to reducing water consumption and related gas emissions arising from their manufacture. In order to ensure that all textile waste is disposed of correctly, we recommend depositing them in specific waste collection centres where these can be segregated into different textile fibre types.

Always follow the disposal recommendations to ensure effective product recycling. And remember that recycling is not only an action, but also a responsible choice to preserve our natural resources.



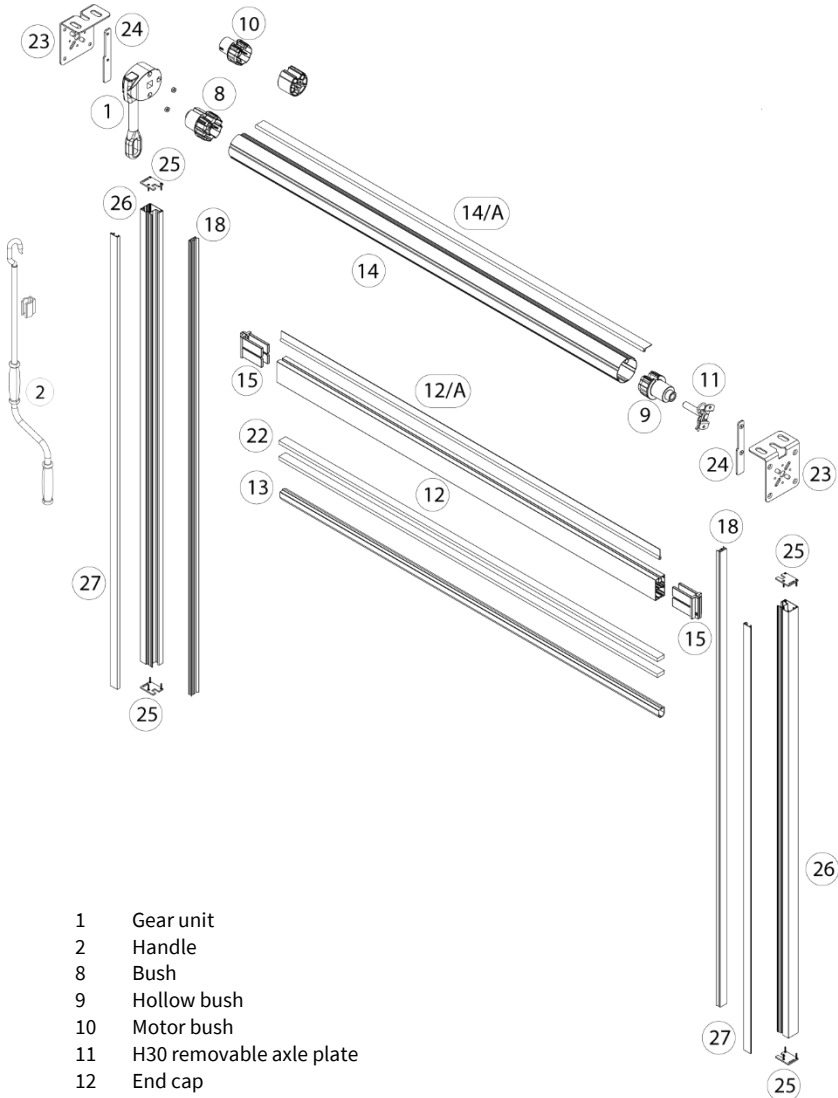

- |      |                          |    |                   |
|------|--------------------------|----|-------------------|
| 1    | Gear unit                |    |                   |
| 2    | Handle                   |    |                   |
| 8    | Bush                     |    |                   |
| 9    | Hollow bush              |    |                   |
| 10   | Motor bush               |    |                   |
| 11   | H30 removable axle plate |    |                   |
| 12   | End cap                  |    |                   |
| 12/A | End slat rain deflector  |    |                   |
| 13   | Weather strip            |    |                   |
| 14   | Axle                     |    |                   |
| 14/A | Axle rain deflector      |    |                   |
| 15   | End cap top              | 24 | Bolt              |
| 18   | Indoor ZIP guide rail    | 25 | Guide rail coiler |
| 22   | End cap platen           | 26 | Guide rail        |
| 23   | Nuvola support           | 27 | Guide rail cover  |

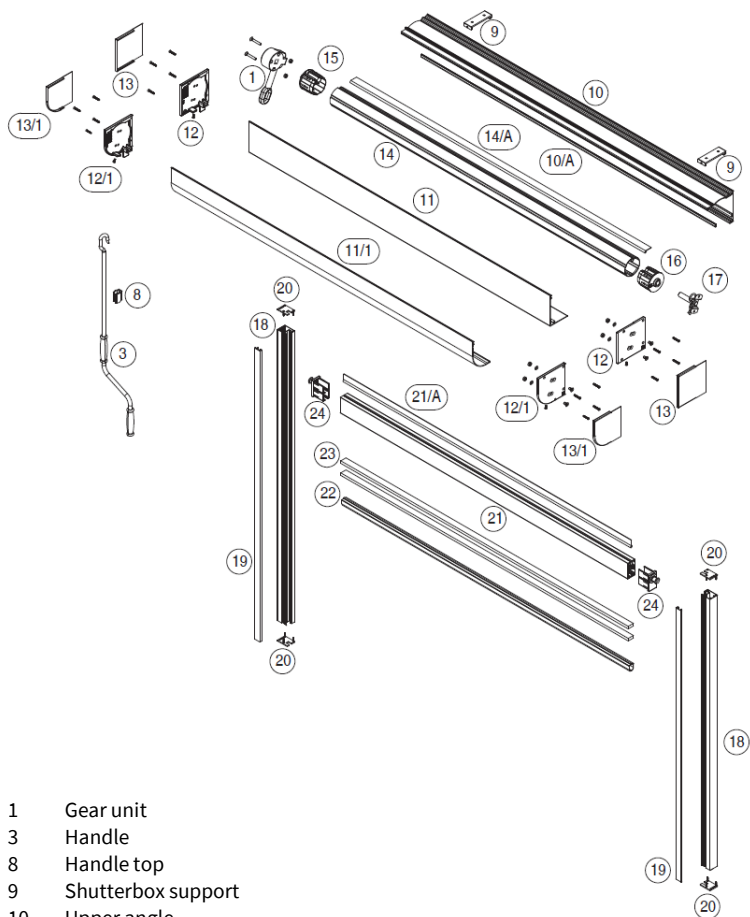

- |      |                          |      |                         |
|------|--------------------------|------|-------------------------|
| 1    | Gear unit                | 18   | Guide rail              |
| 3    | Handle                   | 19   | Guide rail cover        |
| 8    | Handle top               | 20   | Guide rail base         |
| 9    | Shutterbox support       | 21   | End cap                 |
| 10   | Upper angle              | 21/A | End slat rain deflector |
| 10/A | Protecting joint         | 22   | Weather strip           |
| 11   | Ágora shutterbox lid     | 23   | Platen                  |
| 11/1 | Aura shutterbox lid      | 24   | End cap top             |
| 12   | Ágora end cap            |      |                         |
| 12/1 | Aura end cap             |      |                         |
| 13   | Ágora end cap trim       |      |                         |
| 13/1 | Aura end cap trim        |      |                         |
| 14   | Axle                     |      |                         |
| 14/A | Axle rain deflector      |      |                         |
| 15   | Bush with 13x20 axle     |      |                         |
| 16   | Bush with Ø14 hole       |      |                         |
| 17   | H30 removable axle plate |      |                         |

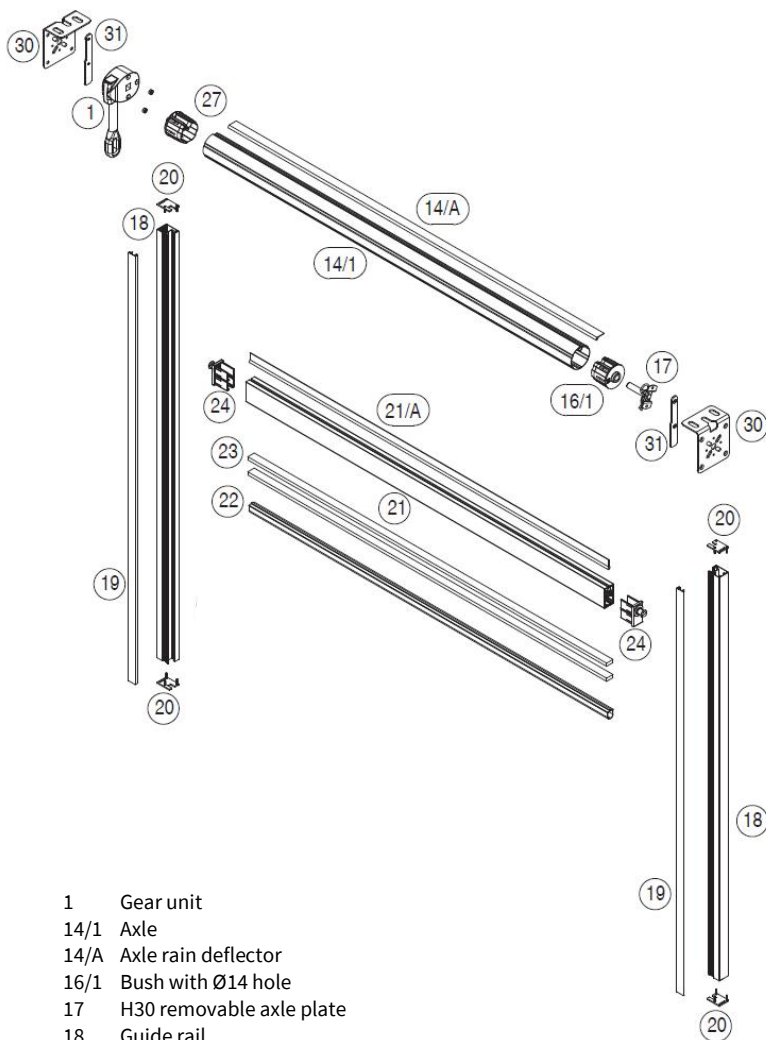

- 1 Gear unit
- 14/1 Axle
- 14/A Axle rain deflector
- 16/1 Bush with Ø14 hole
- 17 H30 removable axle plate
- 18 Guide rail
- 19 Guide rail cover
- 20 Guide rail base
- 21 End cap
- 21/A End slat rain deflector
- 22 Weather strip
- 23 Platen
- 24 End cap top

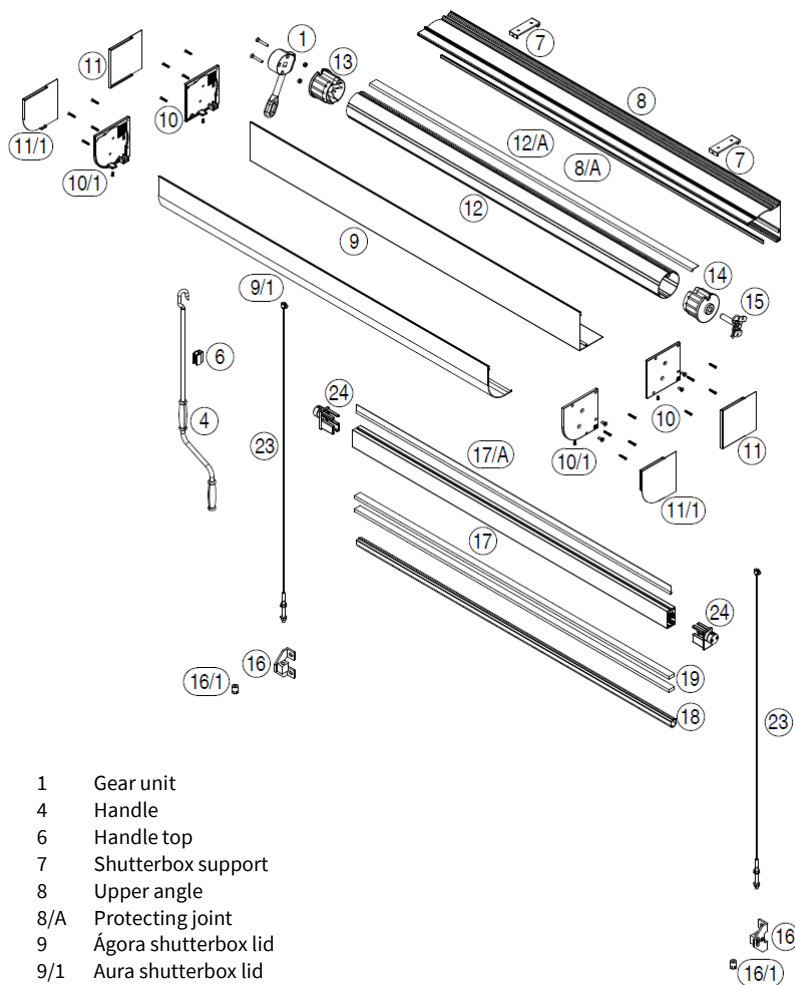

- |      |                               |  |  |
|------|-------------------------------|--|--|
| 1    | Gear unit                     |  |  |
| 4    | Handle                        |  |  |
| 6    | Handle top                    |  |  |
| 7    | Shutterbox support            |  |  |
| 8    | Upper angle                   |  |  |
| 8/A  | Protecting joint              |  |  |
| 9    | Ágora shutterbox lid          |  |  |
| 9/1  | Aura shutterbox lid           |  |  |
| 10   | Ágora end cap                 |  |  |
| 10/1 | Aura end cap                  |  |  |
| 11   | Ágora end cap trim            |  |  |
| 11/1 | Aura end cap trim             |  |  |
| 12   | Axle                          |  |  |
| 12/A | Axle rain deflector           |  |  |
| 13   | Bush with 13x20 axle          |  |  |
| 14   | Bush with Ø14 hole            |  |  |
| 15   | H30 removable axle plate      |  |  |
| 16   | Rod/ cable support            |  |  |
| 16/1 | Stainless steel cable support |  |  |
| 17   | End cap                       |  |  |
| 17/A | End slat rain deflector       |  |  |
| 18   | Weather strip                 |  |  |
| 19   | Platen                        |  |  |
| 23   | Ø4mm Stainless steel cable    |  |  |
| 24   | End cap top                   |  |  |

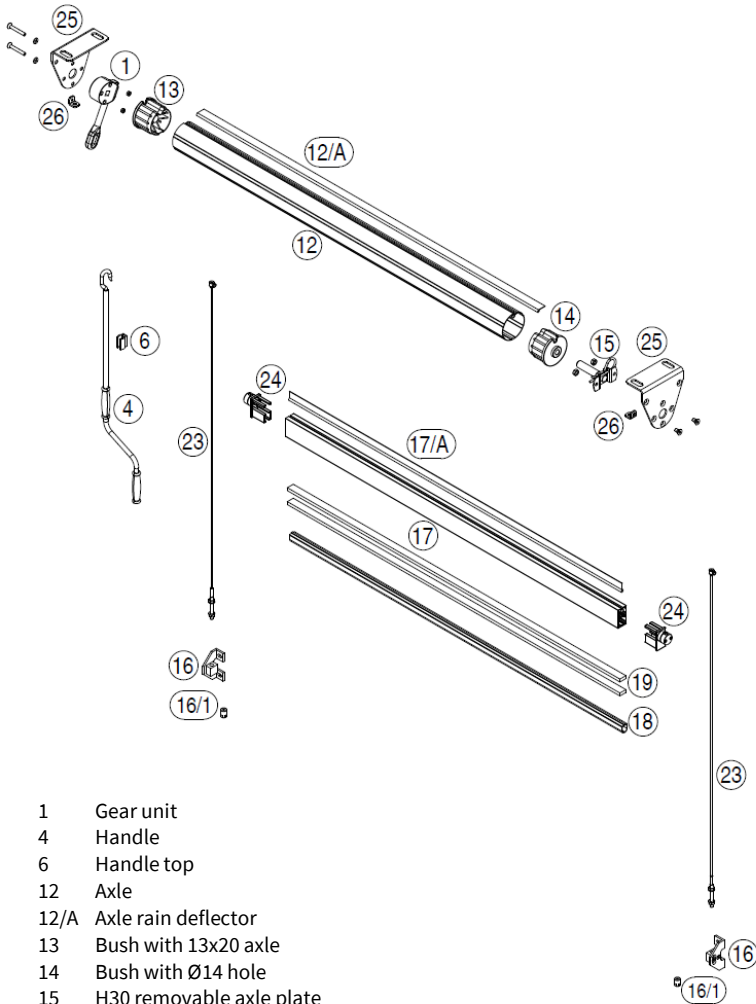

- 1 Gear unit
- 4 Handle
- 6 Handle top
- 12 Axle
- 12/A Axle rain deflector
- 13 Bush with 13x20 axle
- 14 Bush with Ø14 hole
- 15 H30 removable axle plate
- 16 Rod/ cable support
- 16/1 Stainless steel cable support
- 17 End cap
- 17/A End slat rain deflector
- 18 Weather strip
- 19 Platen
- 23 Ø4mm Stainless steel cable
- 24 End cap top
- 25 Nuvola rod/ cable support
- 26 Rod/ cable support

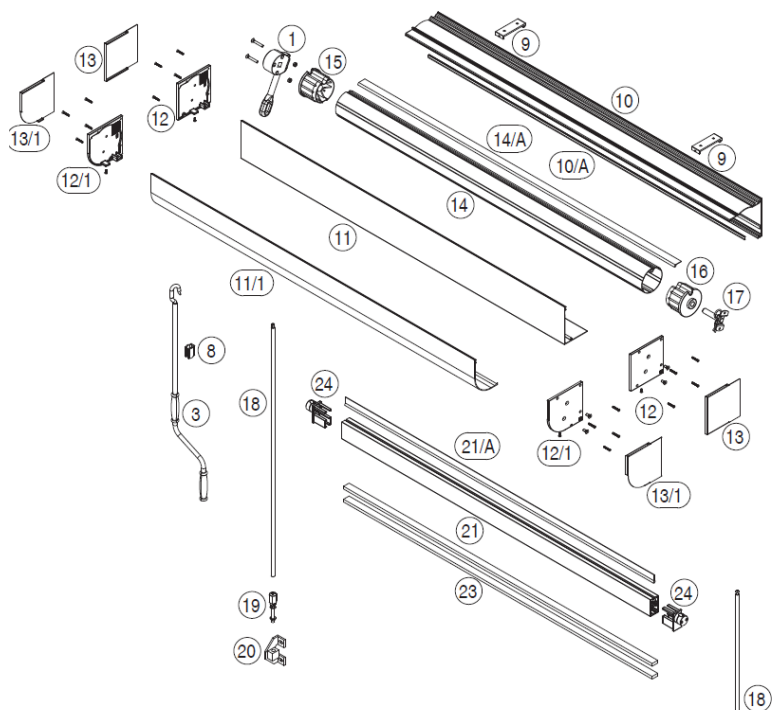





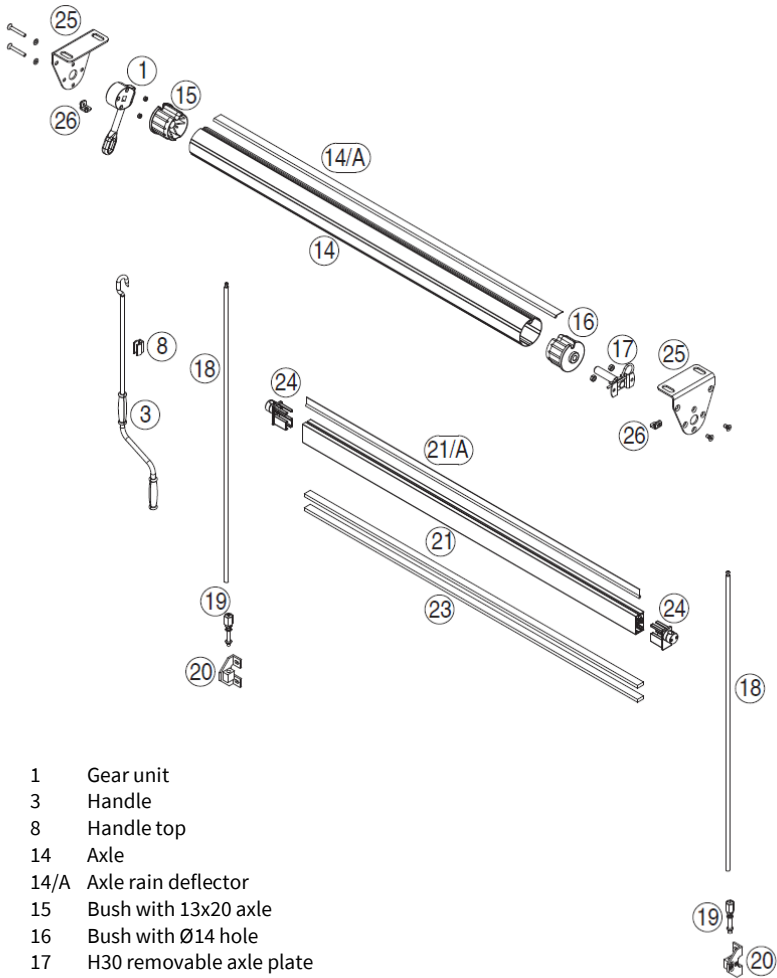













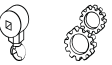

- |      |                           |  |  |
|------|---------------------------|--|--|
| 1    | Gear unit                 |  |  |
| 3    | Handle                    |  |  |
| 8    | Handle top                |  |  |
| 9    | Shutterbox support        |  |  |
| 10   | Shutterbox angle          |  |  |
| 10/A | Protecting joint          |  |  |
| 11   | Ágora shutterbox lid      |  |  |
| 11/1 | Aura shutterbox lid       |  |  |
| 12   | Ágora end cap             |  |  |
| 12/1 | Aura end cap              |  |  |
| 13   | Ágora end cap trim        |  |  |
| 13/1 | Aura end cap trim         |  |  |
| 14   | Axle                      |  |  |
| 14/A | Axle rain deflector       |  |  |
| 15   | Bush with 13x20 axle      |  |  |
| 16   | Bush with Ø14 hole        |  |  |
| 17   | H30 removable axle plate  |  |  |
| 18   | Ø10mm stainless steel rod |  |  |
| 19   | Rod adjuster              |  |  |
| 20   | Rod/ cable support        |  |  |
| 21   | End cap                   |  |  |
| 21/A | End slat rain deflector   |  |  |
| 23   | Platen                    |  |  |
| 24   | End cap top               |  |  |



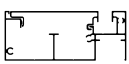
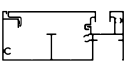

























- 1 Gear unit
- 3 Handle
- 8 Handle top
- 14 Axle
- 14/A Axle rain deflector
- 15 Bush with 13x20 axle
- 16 Bush with Ø14 hole
- 17 H30 removable axle plate
- 18 Ø10mm stainless steel rod
- 19 Stainless steel rod adjuster
- 20 Rod/ cable support
- 21 End cap
- 21/A End slat rain deflector
- 23 Platen
- 24 End cap top
- 25 Nuvola support
- 26 Rod/ cable support

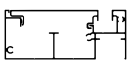
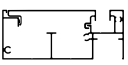

















# ÁGORA

Size	110				130			
System								
Automation								
Guide rail compatibility			-				-	
(Attachment)								
			-				-	
			-				-	
			-				-	
			-				-	

# AURA

Size	110				130				150
System									
Automation									
Guide rail compatibility			-				-		
(Attachment)									
			-				-		
			-				-		
			-				-		
			-				-		

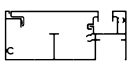
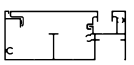
## NUVOLA

Sizes	110				130			
System								
Automation	 				 			
Guide rail compatibility			-				-	
(Attachment)								
								
								

								
---	---	---	---	---	---	---	---	---

## TROUBLESHOOTING

ISSUE	CAUSE	SOLUTION
Fabric slides to one side	Poor awning alignment	Align the fabric correctly
End slat will not go up/down	Thermal motor protection	Place the guide rails correctly
Motor will not operate after several minutes of continued operation	Thermal motor protection	Allow the motor to cool down for a few minutes
Motor is very noisy	Motor breakdown	Technical assistance required
Motor is not moving	Cabling error	Check the electrical circuit against the diagrams provided
	Motor breakdown	Check the motor and replace if needed

## INTRODUCTION

Informations préliminaires  
Mises en garde d'utilisation  
Responsabilité  
Exigences pour l'utilisateur et l'installateur

---

## INSTALLATION ET MISE EN MARCHÉ

Installation  
Mise en marche  
Motorisation et automatismes  
Maintenance / Démontage et élimination

---

## VUE EN ÉCLATÉ COMBINAISONS

---

## PROBLÈMES, CAUSES ET SOLUTIONS

---

## INFORMATIONS PRÉLIMINAIRES



### **Ce manuel ne doit pas être modifié.**

Il s'adresse à toutes les personnes qui vont utiliser le système à tombée verticale (ci-après *store*), comme l'installateur, le mainteneur, le propriétaire ou utilisateur, et constitue l'instrument essentiel pour le bon usage et la maintenance correcte du produit. Les instructions relatives à la manipulation, au déballage, à l'installation et à la mise en marche, au réglage et à la maintenance s'adressent à l'installateur. Les instructions relatives aux modes d'utilisation et de maintenance corrects, ainsi que la garantie, s'adressent au propriétaire.

Ce manuel d'utilisation fait partie intégrante du produit, et il est essentiel à la validité de la garantie. Conservez-le dans sa totalité et dans un lieu facile d'accès de sorte qu'il soit toujours à la disposition du personnel qualifié chargé de l'installation, de la maintenance ou du réglage, pour lui permettre d'effectuer les registres nécessaires.

### MISES EN GARDE D'UTILISATION

- Lisez attentivement les instructions de ce manuel.
- Avant l'installation, vérifiez que le store est en parfait état.
- Assurez-vous que le lieu d'installation est conforme aux conditions de sécurité.
- L'installation doit être réalisée par du personnel qualifié.
- Le fabricant ne sera tenu responsable des dommages causés par un mauvais traitement ou une mauvaise installation du produit.
- Le produit est conforme à la norme *EN 13561 Stores extérieurs. Exigences de performance*, y compris la sécurité, et à la norme *EN 1932 Fermetures pour baies équipées de fenêtres et stores extérieurs. Résistance à la charge de vent. Méthodes d'essai et critères de performance*, et est sorti d'usine en parfait état.
- Il est nécessaire de disposer des outils et de porter les vêtements appropriés pour son installation, tels que gants, lunettes de protection et chaussures de sécurité.
- Si le modèle est équipé d'un moteur électrique, lisez attentivement les instructions du fabricant avant de l'installer.

## RESPONSABILITÉ

Le fabricant ne sera pas tenu responsable des blessures sur des personnes ou des dommages sur l'installation, dus à la non-observation des instructions figurant dans ce manuel concernant l'installation, l'utilisation et la maintenance, ni ceux dus à des actions violentes ou à des manœuvres incorrectes ou à des modifications effectuées sans autorisation préalable.

Pour les opérations de maintenance ou la réparation, on devra utiliser exclusivement des pièces de rechange originales. Le produit est garanti selon les accords stipulés lors de la vente. C'est pourquoi la garantie et le marquage CE ne seront plus valables en cas de non-observation des normes et instructions d'utilisation fournies dans ce manuel.

## EXIGENCES POUR L'UTILISATEUR ET L'INSTALLATEUR

Ces systèmes sont exclusivement destinés à l'usage pour lequel ils ont été conçus. Tout autre usage est inapproprié et donc dangereux. On ne devra en aucun cas installer un produit détérioré car il pourrait provoquer des dommages sur l'installation et donner lieu à des situations dangereuses.

**L'installation doit toujours être réalisée par un installateur professionnel. En cas de doutes ou d'usage non prévu, contactez LaViuda avant installation.**

# AURA / ÁGORA

## ZIP

### INSTALLATION DU COFFRE

Vérifier l'assemblage du coffre et introduire les coulisses intérieures dans les bouts jusqu'à ce qu'elles soient encastrées.

Mettre en position:

- (D) Installation sur intérieur creux.
- (E) Installation en extérieur façade.
- (F) Installation autoportante.

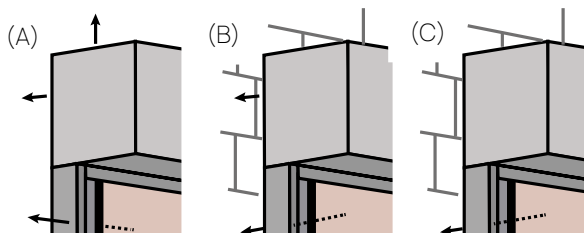
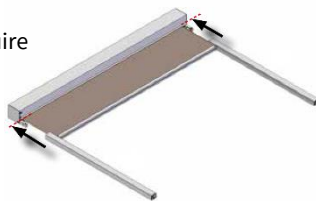

### INSTALLATION DU COFFRE AVEC SUPPORTS

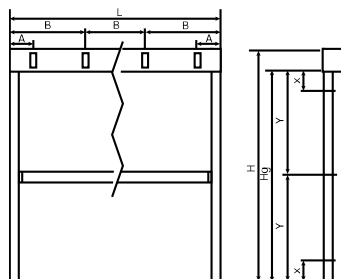

Fixer les supports correspondant en fonction de si le montage est au plafond ou au mur, selon le schéma d'installation et à l'aide des systèmes de fixation recommandés.



(SCHÉMA D'INSTALLATION)

L		A	B	H		X	Y
supports				orifice de fixation			
0-1500	2	150	-	0-1000	2	90	-
1501-3000	3	150	L/2	1001-2000	3	90	Hg / 2
3001-4000	4	150	L/3	2001-2500	4	90	Hg / 3
4001-5000	5	150	L/4	3001-4000	5	90	Hg/4
5001-6500	6	150	L/5	4001-5000	6	90	Hg/5
6501-8000	7	150	L/6	5001-6000	7	90	Hg/6



SYSTÈMES DE FIXATION RECOMMANDÉS		
HSL-3-SK		BÉTON
Hilti HRD-U10 Hilti HRD-S10		BÉTON BRIQUE PERFORÉE BRIQUE PLEINE
HUD-1 HUD-L		

*Dans des environnements corrosifs, il est recommandé d'utiliser des ancrages en acier inoxydable*

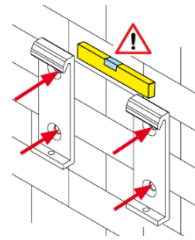

## Séquence d'opération de pose des ancrages:

ANCRAGE MÉCANIQUE		ANCRAGE CHIMIQUE	
	<b>1</b> Percez un trou avec le foret de la perceuse approprié au type d'ancrage.		<b>1</b> Percez un trou avec le foret de la perceuse approprié au type d'ancrage.
	<b>2</b> Faites attention à la profondeur d'exécution du trou.		<b>2</b> Faites attention à la profondeur d'exécution du trou.
	<b>3</b> Faites sortir la poussière et les fragments du trou (l'air comprimé est idéal)		<b>3</b> Faites sortir la poussière et les fragments du trou avec une brosse.
	<b>4</b> Installez l'ancrage.		<b>4</b> Faites sortir les restes de poussière avec de l'air comprimé.
	<b>5</b> Serrez jusqu'à atteindre le couple de serrage recommandé (voir catalogue Hilti).		<b>5</b> Injectez l'adhésif chimique.
	<b>6</b> Configuration finale.		<b>6</b> Introduisez et ajustez l'ancrage en respectant le temps de repos avant de poser la plaque (voir la sur cartouche du produit).
			<b>7</b> Poser la plaque et serrer jusqu'au couple de serrage recommandé (voir catalogue Hilti).

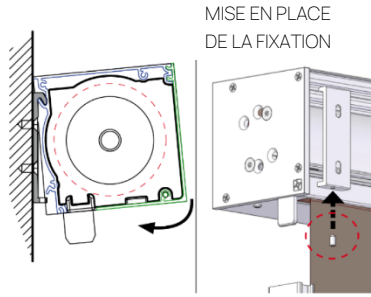

**Ancrage au mur:** Placer le coffre sur sa position et le fixer par l'arrière.

**Ancrage au plafond:** retirer le couvercle pour accéder au support. Poser le coffre sur les onglets du support et le fixer en vissant la vis sans tête du support sur le profil.

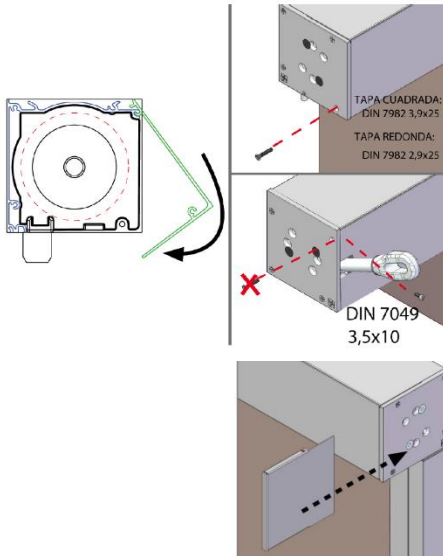
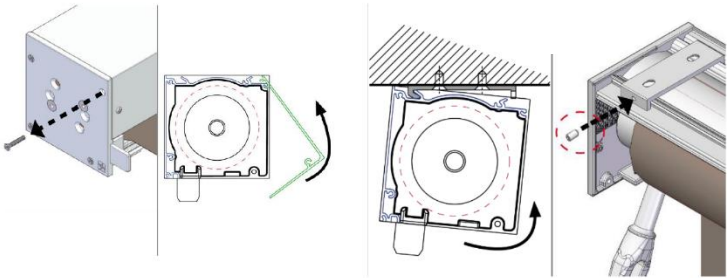

\* En installation d'intérieur creux, la trappe doit être fixée sur la face intérieur et jamais sur le côté, afin de pouvoir l'ouvrir ultérieurement.

Glisser les trappes enjoliveuses sur les bouts latéraux (s'il y a lieu).

## INSTALLATION DES COULISSES

Poser les trappes sur les coulisses et les fixer avec des vis DIN 7982 3,5x25. Introduire les coulisses de sorte qu'elles s'encastrent avec les abouts.

Mettre en position, que ce soit intérieur creux, extérieur façade ou encastré, selon le schéma de montage précédent.

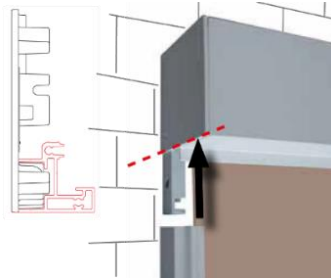

Une fois les coulisses en place, baisser le complètement le store et vérifier qu'elles sont nivelées. Ensuite, fermer le store et fixer les coulisses.

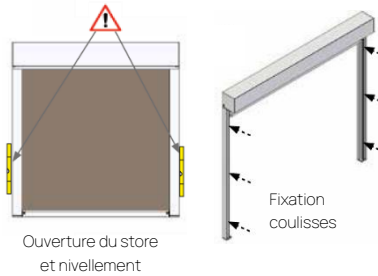

Visser les coulisses à l'aide de vis DIN 7981 M3,9x16, conformément à la position suivante:

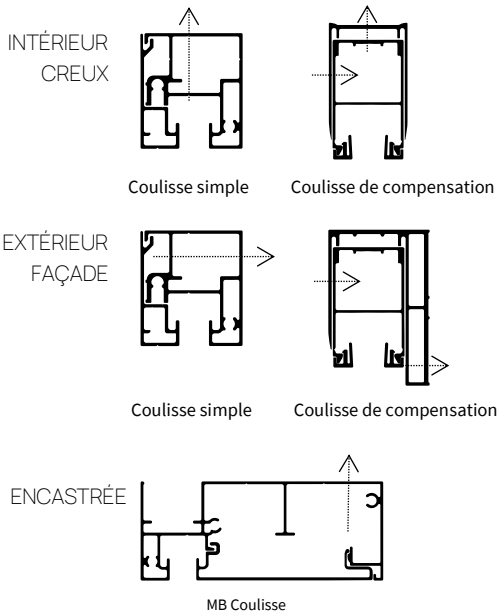



Avec le store sur la partie supérieure, introduire la coulisse intérieur ZIP dans la fermeture à glissière du tissu.

Une fois en place, insérer le cache (A) de la coulisse en faisant pression.

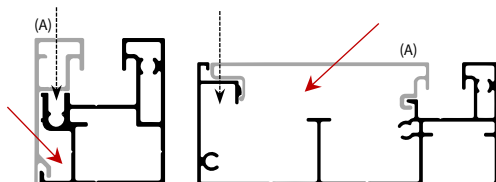

### Coulisse compensatoire:



Fixer le profil coulisse compensatoire (loge-coulisse) et le coffre. La patte de la console droit entrer dans le logement du profil.

Introduire le coulisse ZIP dans le coulisse compensatoire.



La crémallière doit entrer dans le profil rail intérieur. C'est très important de vérifier ce point.

Une fois introduite la toile, braisser la toile jusque'au point inférieur.

Lors de la descente, le profil se repositionne lui même.

Une fois repositionné, il est nécessaire de fixer le profil de coulisse sur le coulisse compensatoire avec des vis (les vis seront visibles sur leur face plate).

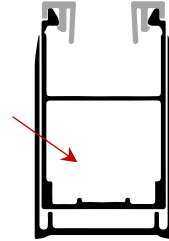

## RÉGLAGE DU STORE

Régler les fins de course du moteur si nécessaire. Pour le bon fonctionnement du store, baisser et lever la toile complètement plusieurs fois pour le positionner correctement.

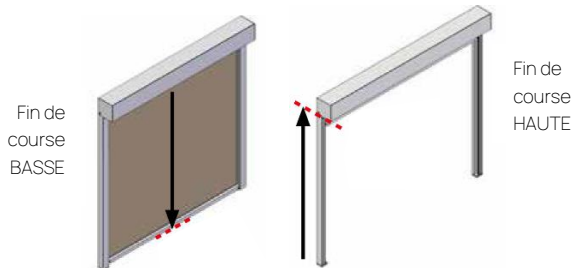

**Lorsque la toile est étendue, elle peut présenter des rides ou des marques si elle est restée enroulée longtemps. Cela n'est PAS un problème car ces marques disparaîtront avec le temps lorsque la toile se sera stabilisée.**

# NUVOLA

## ZIP



### INSTALLATION DES ABOUTS

Joindre les goujons et les abouts, et les mettre dans leur position. Introduire les coulisses intérieures jusqu'à ce qu'elles soient encastrées. Fixer selon montage:

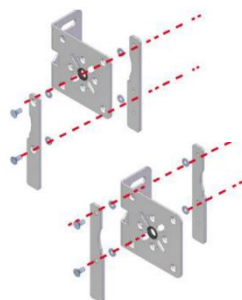
- (D) Installation sur intérieur creux.
- (E) Installation en extérieur façade.
- (F) Installation autoportante.



### SYSTÈMES DE FIXATION RECOMMANDÉS

HSL-3-SK		BÉTON
Hilti HRD-U10 Hilti HRD-S10		BÉTON BRIQUE PERFORÉE BRIQUE PLEINE
HUD-1 HUD-L		

*Dans des environnements corrosifs, il est recommandé d'utiliser des ancrages en acier inoxydable*

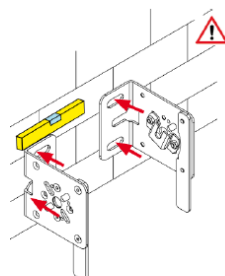

\* Voir séquence du système d'ancrage en page 7

Introduire le cylindre et son joint sur le côté libre de l'axe, et poser les abouts. Introduire les passants sur la tête du moteur et sur le côté libre, pour le fixer.

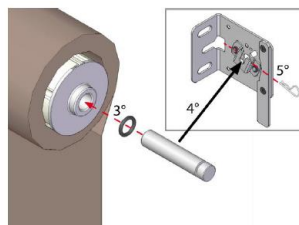
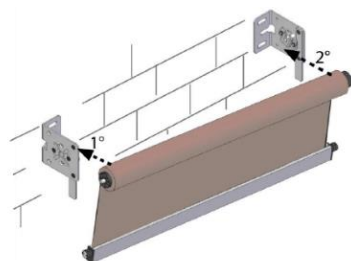

## INSTALLATION DES COULISSES

Poser les trappes sur les coulisses et les fixer avec des vis DIN 7982 3,5x25. Introduire les coulisses par les goujons, et vérifier avec un niveau qu'elles sont bien positionnées.

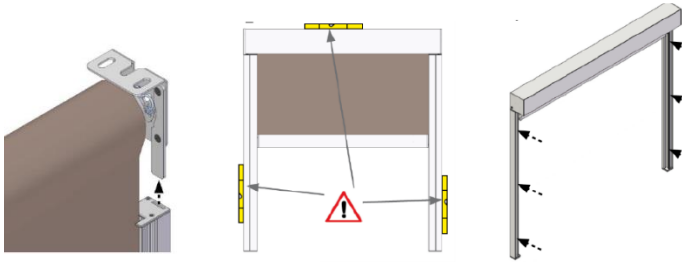

Mettre en position, que ce soit intérieur creux, extérieur façade ou encastré, selon le schéma de montage précédent. Visser les coulisses à l'aide de vis DIN 7981 M3,9x16, conformément à la position suivante:

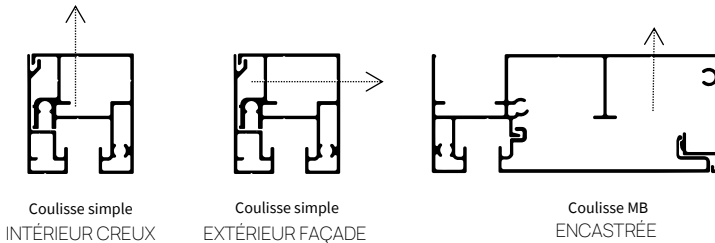

Une fois les coulisses fixées sur leur position, introduire les coulisses intérieures ZIP de sorte que la fermeture à glissière se retrouve à l'intérieur.

Fermer l'ensemble avec le cache de la coulisse.

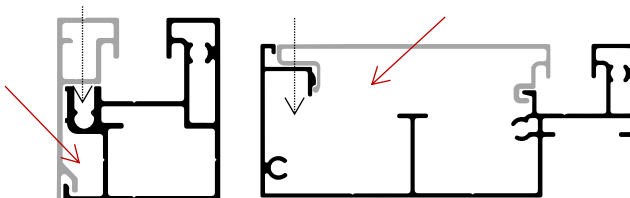

## RÉGLAGE DU STORE

Régler les fins de course du moteur si nécessaire. Pour le bon fonctionnement du store, baisser et lever la toile complètement plusieurs fois pour le positionner correctement.

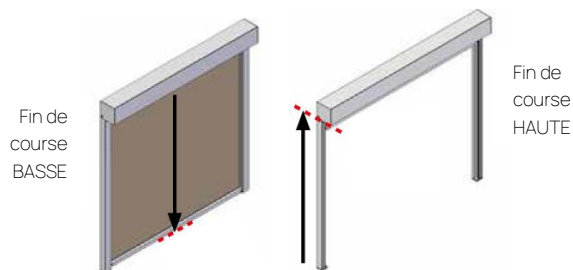

**Lorsque la toile est étendue, elle peut présenter des rides ou des marques si elle est restée enroulée longtemps. Cela n'est PAS un problème car ces marques disparaîtront avec le temps lorsque la toile se sera stabilisée.**



## AURA / ÁGORA COULISSE

### INSTALLATION DU COFFRE

Placer les bouts dans leur position et introduire les coulisses intérieures jusqu'à ce qu'elles soient encastrées. Fixer selon montage:

- (A) Installation sur intérieur creux.
- (B) Installation en extérieur façade.
- (C) Installation autoportante.

### INSTALLATION DU COFFRE AVEC SUPPORTS

Optionnellement, le coffre peut être fixé au moyen de supports. Pour cela, mettre en place et fixer les supports en s'assurant qu'ils sont nivelés.

(SCHÉMA D'INSTALLATION)

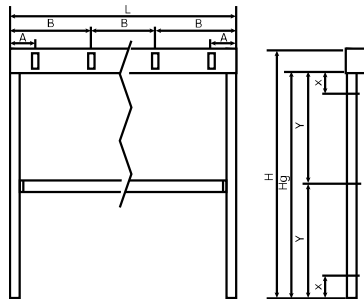

L	A	B	H	X	Y		
supports	orifice de fixations						
0-1500	2	150	-	0-1000	2	90	-
1501-3000	3	150	L/2	1001-2000	3	90	Hg / 2
3001-4000	4	150	L/3	2001-3000	4	90	Hg / 3
4001-5000	5	150	L/4	3001-4000	5	90	Hg / 4
			4001-5000	6	90	Hg / 5	

### SYSTÈMES DE FIXATION RECOMMANDÉS

HSL-3-SK		BÉTON
Hilti HRD-U10 Hilti HRD-S10		BÉTON
HUD-1 HUD-L		BRIQUE PERFORÉE BRIQUE PLEINE

*is des environnements corrosifs, il est recommandé d'utiliser des ancrages en acier inoxydable*

\* Voir séquence du système d'ancrage en page 7

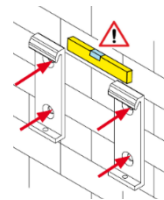

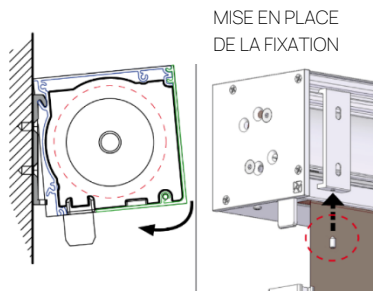

**Ancre au mur:** placer le coffre dans sa position et le fixer par l'arrière.

**Ancre au plafond:** retirer le couvercle pour accéder au support. Poser le coffre sur les onglets du support et le fixer en vissant la vis sans tête du support sur le profil.

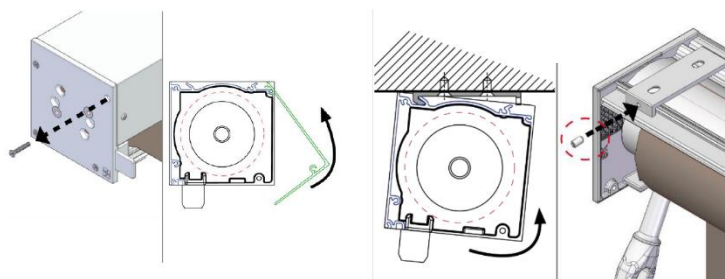

### INSTALLATION DES COULISSES

Poser les trappes sur les coulisses et les fixer avec des vis DIN 7982 3,5x25. Introduire les coulisses par les goujons de l'about et vérifier qu'elles sont nivelées.

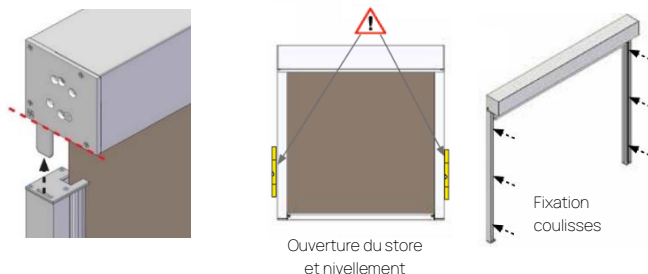

Mettre en position, que ce soit intérieur creux, extérieur façade ou encastré, selon le schéma de montage précédent. Visser les coulisSES à l'aide de vis DIN 7981 M3,9x16.

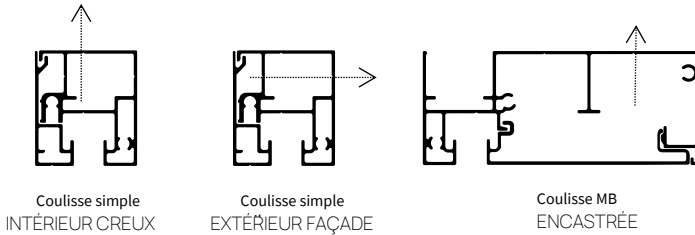

## RÉGLAGE DU STORE

Régler les fins de course du moteur si nécessaire. Pour le bon fonctionnement du store, baisser et lever la toile complètement plusieurs fois pour le positionner correctement.

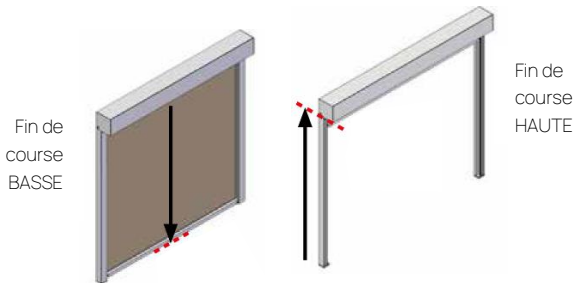

**Lorsque la toile est étendue, elle peut présenter des rides ou des marques si elle est restée enroulée longtemps. Cela n'est PAS un problème car ces marques disparaîtront avec le temps lorsque la toile se sera stabilisée.**

## NUVOLA COULISSE

### INSTALLATION DES ABOUTS

Joindre les goujons et les abouts, et les mettre dans leur position. Introduire les coulisses intérieures jusqu'à ce qu'elles soient encastrées. Fixer selon montage:

- (D) Installation sur intérieur creux.
- (E) Installation en extérieur façade.
- (F) Installation autoportante.

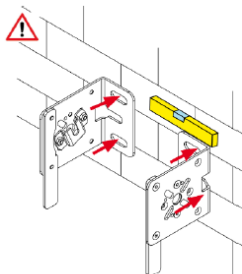

### SYSTÈMES DE FIXATION RECOMMANDÉS

HSL-3-SK



BÉTON

Hilti HRD-U10



Hilti HRD-S10



HUD-1



HUD-L



BÉTON  
BRIQUE PERFORÉE  
BRIQUE PLEINE

*Dans des environnements corrosifs, il est recommandé d'utiliser des ancrages en acier inoxydable*

*\* Voir séquence du système d'ancrage en page 7*

Introduire le cylindre avec son joint sur le côté libre de l'axe.

Placer l'axe dans les abouts. Introduire les passants sur la tête du moteur et sur le côté libre, pour le fixer.

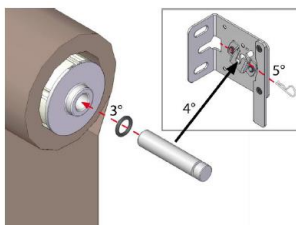
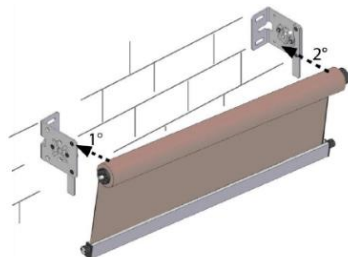

## INSTALLATION DES COULISSES

Poser les trappes sur les coulisses et les fixer avec des vis DIN 7982 3,5x25. Introduire les coulisses par les goujons de l'about et vérifier qu'elles sont nivelées. Mettre en position, que ce soit intérieur creux, extérieur façade ou encastré, selon le schéma de montage précédent. Visser les coulisses à l'aide de vis DIN 7981 M3,9x16.

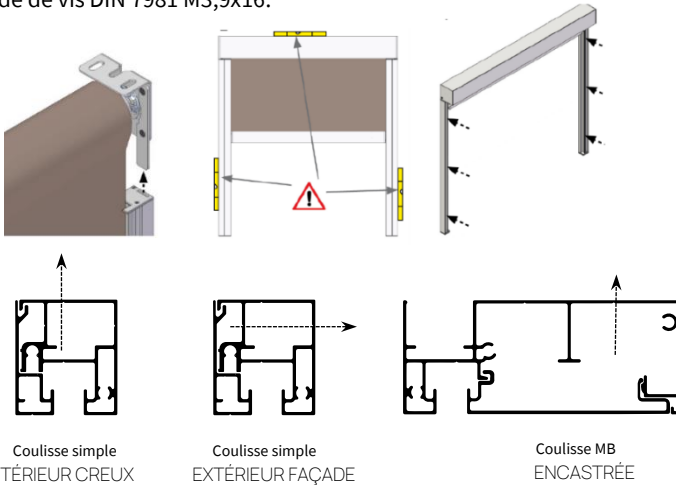

## RÉGLAGE DU STORE

Régler les fins de course du moteur si nécessaire. Pour le bon fonctionnement du store, baisser et lever la toile complètement plusieurs fois pour le positionner correctement.

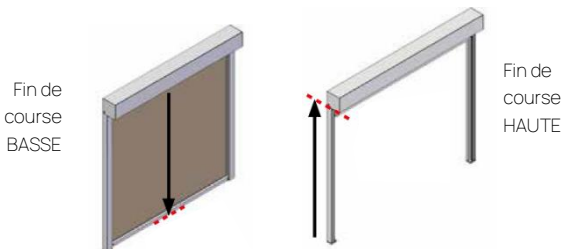

**Lorsque la toile est étendue, elle peut présenter des rides ou des marques si elle est restée enroulée longtemps. Cela n'est PAS un problème car ces marques disparaîtront avec le temps lorsque la toile se sera stabilisée.**

## AURA / ÁGORA CÂBLE

### INSTALLATION DU COFFRE

Placer les abouts dans leur position et les fixer selon montage :

- (A) Installation sur intérieur creux.
- (B) Installation en extérieur façade.

### INSTALLATION DU COFFRE AVEC SUPPORTS

Optionnellement, le coffre peut être fixé au moyen de supports. Pour cela, mettre en place et fixer les supports en s'assurant qu'ils sont nivelés.

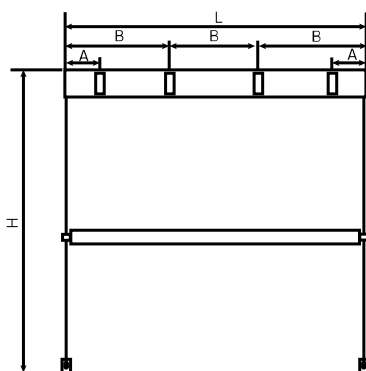
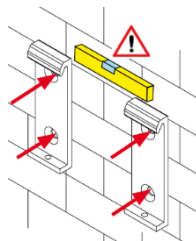

(SCHEMA D'INSTALLATION)

L	supports	A	B
0-1500 L (sopores)	2	150	- B
1501-3000 0-1500	3	150	L/2
3001-4000 1501-3000	4	150	L/3
4001-5000 3001-4000	5	150	L/4
4001-5000	5	150	L/4

### SYSTÈMES DE FIXATION RECOMMANDÉS

HSL-3-SK



BÉTON

Hilti HRD-U10



Hilti HRD-S10



HUD-1



HUD-L



BETÓN  
BRIQUE PERFORÉE  
BRIQUE PLEINE

*Dans des environnements corrosifs, il est recommandé d'utiliser des ancrages en acier inoxydable*

\* Voir séquence du système d'ancrage en page 7

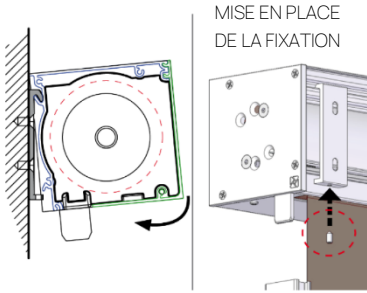

**Ancrage au mur:** placer le coffre dans sa position et le fixer par l'arrière.

**Ancrage au plafond:** retirer le couvercle pour accéder au support. Poser le coffre sur les onglets du support et le fixer en vissant la vis sans tête du support sur le profil.

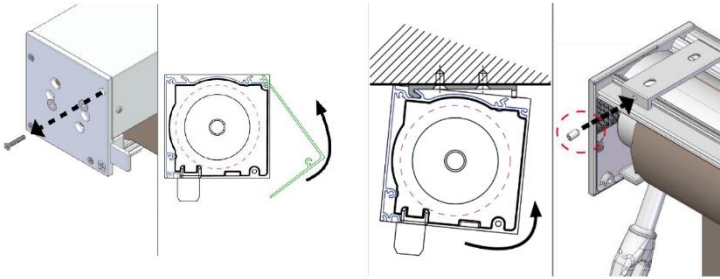

## FIXATION DU CÂBLE

Placer le câble selon le schéma suivant. Le fixer à l'about, à l'extrémité et au support.

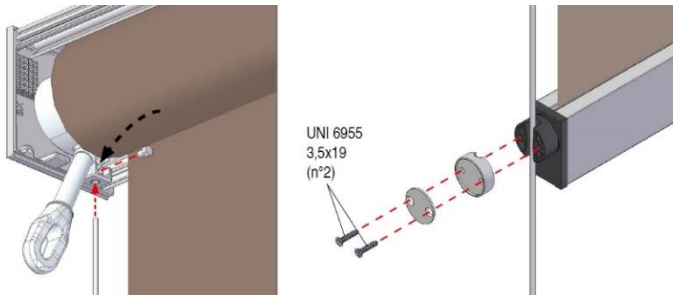

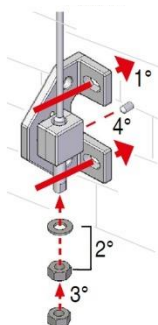
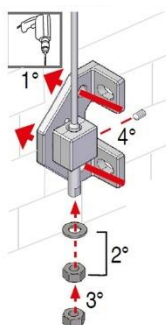
INSTALLATION  
EN EXTÉRIEUR  
FAÇADEINSTALLATION  
EN INTÉRIEUR  
CREUX

INSTALLATION AU SOL

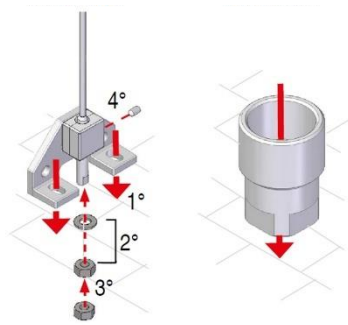

## RÉGLAGE DU STORE

Régler les fins de course du moteur si nécessaire. Pour le bon fonctionnement du store, baisser et lever la toile complètement plusieurs fois pour le positionner correctement.

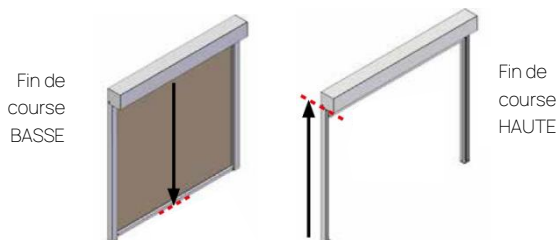

**Lorsque la toile est étendue, elle peut présenter des rides ou des marques si elle est restée enroulée longtemps. Cela n'est PAS un problème car ces marques disparaîtront avec le temps lorsque la toile se sera stabilisée**



## NUVOLA CÂBLE

### INSTALLATION DES ABOUTS

Joindre les goujons et les abouts, et les mettre dans leur position. Introduire les coulisses intérieures jusqu'à ce qu'elles soient encastrées. Fixer selon montage:

- (A) Instalación en interior hueco.
- (B) Instalación en exterior fachada.



INSTALLATION  
AU MUR



INSTALLATION  
AU PLAFOND



### SYSTÈMES DE FIXATION RECOMMANDÉS

HSL-3-SK		BÉTON
Hilti HRD-U10 Hilti HRD-S10		BÉTON BRIQUE PERFORÉE BRIQUE PLEINE
HUD-1 HUD-L		

*Dans des environnements corrosifs, il est recommandé d'utiliser des ancrages en acier inoxydable*

\* Voir séquence du système d'ancrage en page 7

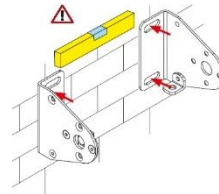

Introduire le cylindre avec son joint sur le côté libre de l'axe.

Placer l'axe dans les abouts.  
Introduire les passants sur la tête du moteur et sur le côté libre, pour le fixer.

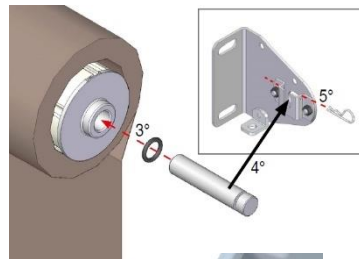
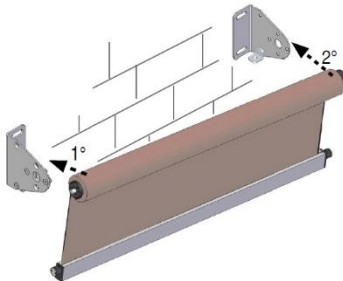

### FIXATION DU CÂBLE

Placer le câble selon le schéma suivant. Le fixer à l'about, à l'extrémité et au support.

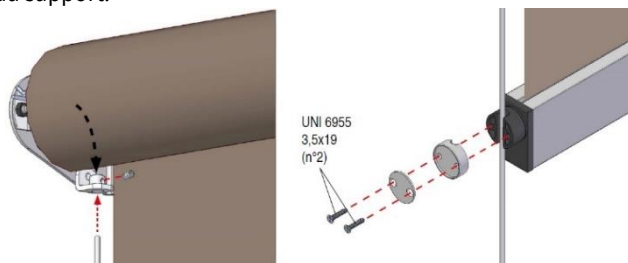

INSTALLATION EN EXTÉRIEUR FAÇADE

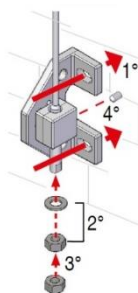

INSTALLATION EN INTÉRIEUR CREUX

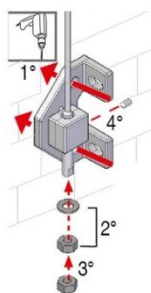

INSTALLATION AU SOL

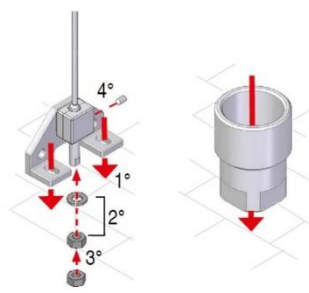

### RÉGLAGE DU STORE

Régler les fins de course du moteur si nécessaire. Pour le bon fonctionnement du store, baisser et lever la toile complètement plusieurs fois pour le positionner correctement.

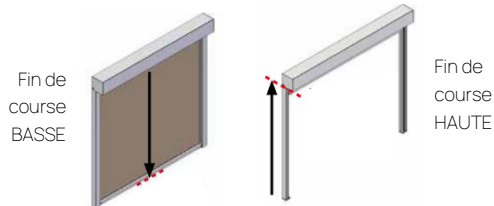

**Lorsque la toile est étendue, elle peut présenter des rides ou des marques si elle est restée enroulée longtemps. Cela n'est PAS un problème car ces marques disparaîtront avec le temps lorsque la toile se sera stabilisée.**

## AURA / ÁGORA TIGE

### INSTALLATION DU COFFRE

Placer les abouts dans leur position et les fixer selon montage:

- (A) Installation sur intérieur creux
- (B) Installation en extérieur façade.

### INSTALLATION DU COFFRE AVEC SUPPORTS

Optionnellement, le coffre peut être fixé au moyen de supports. Pour cela, mettre en place et fixer les supports en s'assurant qu'ils sont nivelés.

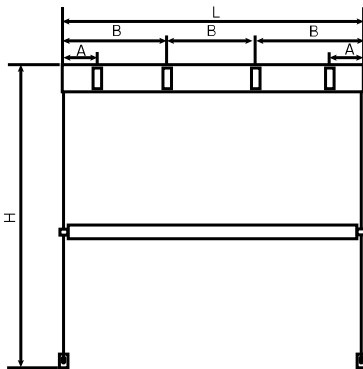
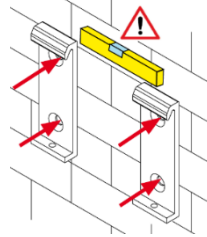

(SCHÉMA D'INSTALLATION)

L	A	B
0-1500	2	A/2
0-1500-3000	2-3	1/2
1500-3000	3-4	L/2-3
3000-4000	4-5	L/3-4
4001-5000	5	L/4

### SYSTÈMES DE FIXATION RECOMMANDÉS

HSL-3-SK		BÉTON
Hilti HRD-U10 Hilti HRD-S10		BÉTON BRIQUE PERFORÉE BRIQUE PLEINE
HUD-1 HUD-L		

*Dans des environnements corrosifs, il est recommandé d'utiliser des ancrages en acier inoxydable*

*\* Voir séquence du système d'ancrage en page 7*

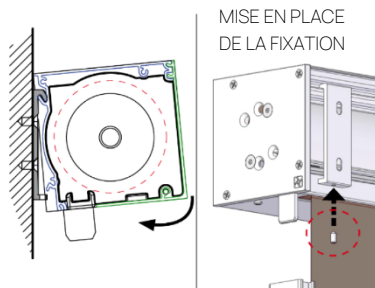

**Ancrage au mur:** placer le coffre dans sa position et le fixer par l'arrière.

**Ancrage au plafond:** retirer le couvercle pour accéder au support. Poser le coffre sur les onglets du support et le fixer en vissant la vis sans tête du support sur le profil.

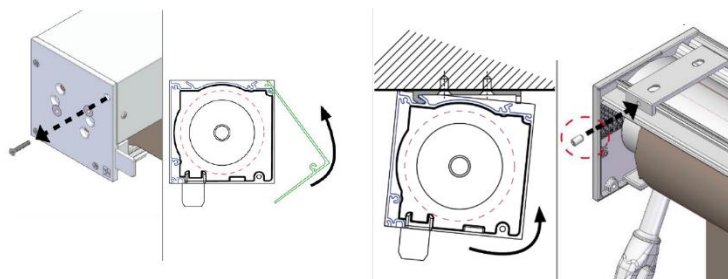

### FIXATION DU CÂBLE

Placer le câble selon le schéma suivant. Le fixer à l'about, à l'extrémité et au support.

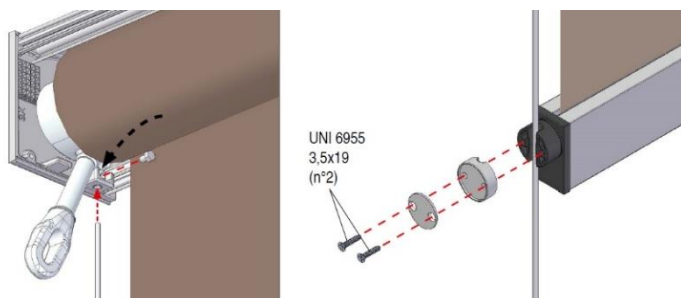

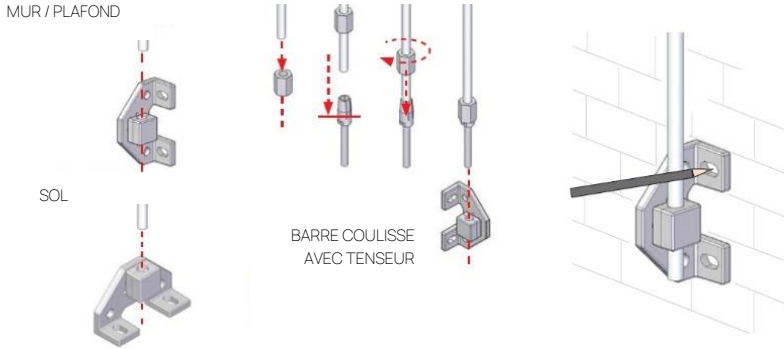

## RÉGLAGE DU STORE

Régler les fins de course du moteur si nécessaire. Pour le bon fonctionnement du store, baisser et lever la toile complètement plusieurs fois pour le positionner correctement.

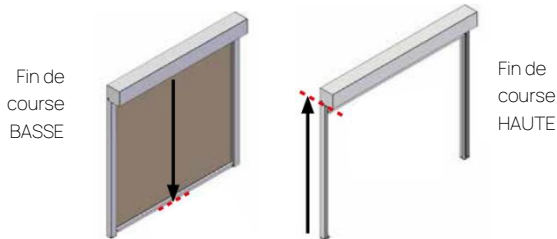

**Lorsque la toile est étendue, elle peut présenter des rides ou des marques si elle est restée enroulée longtemps. Cela n'est PAS un problème car ces marques disparaîtront avec le temps lorsque la toile se sera stabilisée.**

## NUVOLA TIGE

### INSTALLATION DES ABOUTS

Joindre les goujons et les abouts, et les mettre dans leur position. Introduire les coussinets intérieurs jusqu'à ce qu'elles soient encastrées. Fixer selon montage:

- (A) Installation sur intérieur creux.
- (B) Installation en extérieur façade.

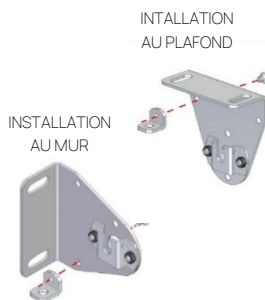

### SYSTÈMES DE FIXATION RECOMMANDÉS

HSL-3-SK		BÉTON
Hilti HRD-U10 Hilti HRD-S10		BÉTON BRIQUE PERFORÉE BRIQUE PLEINE
HUD-1 HUD-L		

*Dans des environnements corrosifs, il est recommandé d'utiliser des ancrages en acier inoxydable*

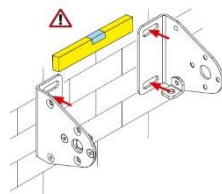

\* Voir séquence du système d'ancrage en page 7

Introduire le cylindre avec son joint sur le côté libre de l'axe.

Placer l'axe dans les abouts. Introduire les passants sur la tête du moteur et sur le côté libre, pour le fixer.

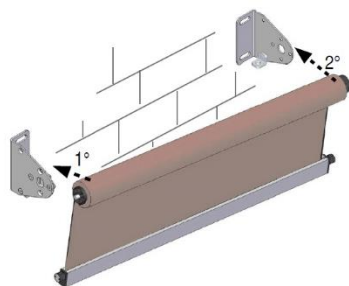
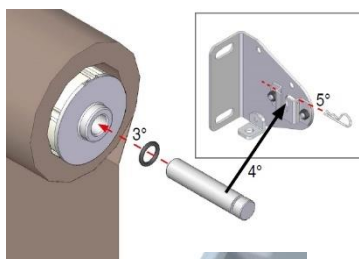

## FIXATION DE LA TIGE

Placer la tige selon le schéma suivant. Le fixer à l'about, à l'extrémité et au support.

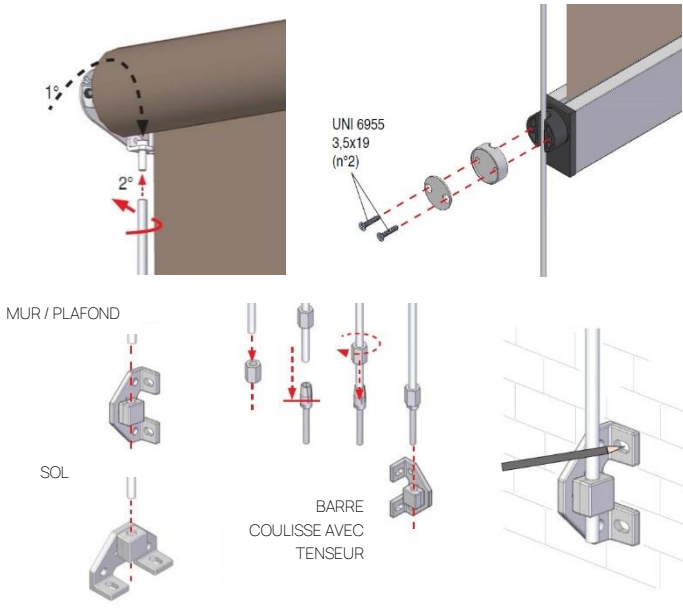

## RÉGLAGE DU STORE

Régler les fins de course du moteur si nécessaire. Pour le bon fonctionnement du store, baisser et lever la toile complètement plusieurs fois pour le positionner correctement.

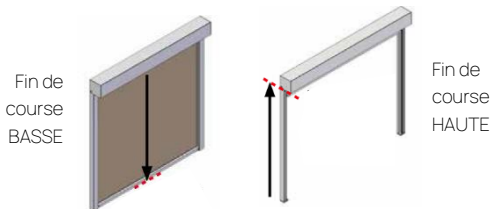

**Lorsque la toile est étendue, elle peut présenter des rides ou des marques si elle est restée enroulée longtemps. Cela n'est PAS un problème car ces marques disparaîtront avec le temps lorsque la toile se sera stabilisée.**

## MOTOR

L'installation du moteur Senso RX de Cherubini devra être effectuée par un professionnel de la motorisation et de l'automatisation du logement, à qui s'adresse ce manuel.

L'installateur devra en outre observer les réglementations et la législation en vigueur dans le pays d'installation, et informer ses clients des conditions d'utilisation et de maintenance du produit. Tout usage distinct de l'application établie par Cherubini sera considéré usage inapproprié. Ceci, et toute non-observation des instructions figurant dans ce guide, impliquera l'exclusion de la responsabilité et de la garantie de la part de Cherubini.

### RACCORDEMENT ÉLECTRIQUE

Pour éviter un mauvais fonctionnement ou des situations de danger, les éléments électriques de commande connectés au moteur doivent être dimensionnés selon les caractéristiques électriques du moteur.

- La déconnexion électrique d'un dispositif doit être prévue sur le réseau électrique conformément aux règles d'installation nationales.
- En cas d'utilisation en extérieur, utiliser un câble d'alimentation avec désignation H05RN-F et une teneur en carbone d'au moins 2 %.
- Si le câble blanc n'est pas utilisé, il doit toujours être isolé. Il est dangereux de toucher le câble blanc lorsque le moteur est raccordé au courant.
- L'installation du bouton est optionnelle. Il est relié à la Phase (câble marron) ou au Neutre (câble bleu) indistinctement. Avec le bouton, le moteur fonctionnera en mode pas à pas (montée, arrêt, descente, arrêt...).

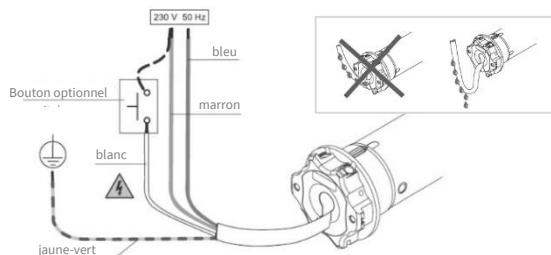



## MISE EN MARCHÉ

### (VI) Ouverture de la programmation de l'émetteur

Pour éviter des modifications accidentelles de la programmation du moteur pendant l'utilisation, la possibilité de réaliser des programmations est automatiquement désactivée 8 heures après la dernière séquence.

- OUVERTURE/FERMETURE SUR ÉMETTEURS POP PLUS / POP LUX / POP LUX / SKIPPER PLUS / SKIPPER LUX / SKIPPER PLUX

- Vérifier l'état de la fonction:



- Permettre la programmation:

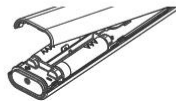

Retirer et mettre les piles

- Bloquer la programmation:



▪ OUVERTURE/ FERMETURE SUR ÉMETTEURS SKIPPER / SÉRIE GIRO / ÉMETTEUR POP

- Vérifier l'état de la fonction:

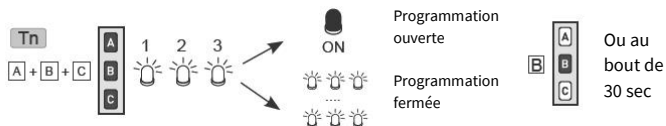

- Permettre la programmation:

OPTION 1



OPTION 2

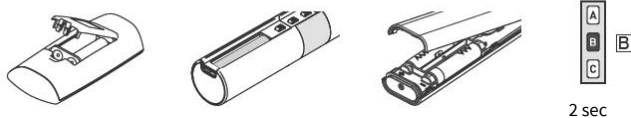

- Bloquer la programmation:



▪ MÉMORISATION DU PREMIER ÉMETTEUR

Cette opération se fait lorsque le moteur est neuf ou que la totalité de la mémoire du moteur a été annulée. Pendant cette phase, pour éviter des interférences, alimenter un seul moteur.

Les voutons doivent être pressés comme indiqué dans la séquence, sans attendre plus de 4 secondes entre une étape et la suivante.

Sinon, l'ordre ne sera pas accepté, et devra être répété.

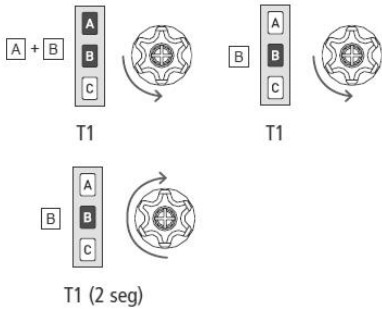

- Appuyer simultanément sur A et B. Ensuite, appuyer sur B. Dans les deux cas, à la fin, le moteur effectue une brève rotation dans un sens.
- Appuyer sur B pendant 2 sec. Pour valider, le moteur effectue une rotation longue en sens contraire.

Voici deux exemples de séquences incomplètes:

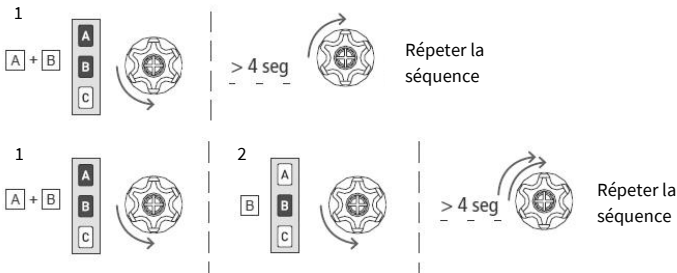

À chaque fois que le moteur reçoit du courant, il y a trois heures pour la mémorisation du premier émetteur. Une fois ce temps écoulé, l'option de mémorisation du premier émetteur est désactivée. Pour rétablir le temps de la fonction, couper et remettre le courant.

## ■ MÉMORISATION D'AUTRES ÉMETTEURS

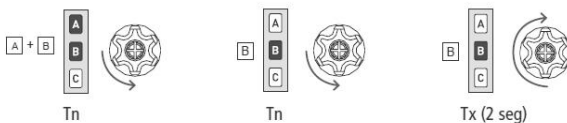

*Tn: émetteur déjà mémorisé*

*Tx: émetteur à mémoriser*

### ■ ANNULATION D'UN ÉMETTEUR

Il est possible d'annuler individuellement tous les émetteurs mémorisés. Une fois le dernier émetteur annulé, le moteur revient aux conditions initiales.

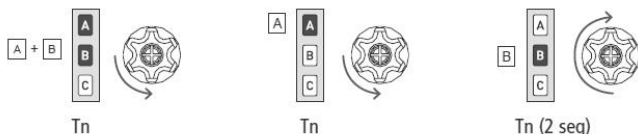

*Tn: émetteur déjà mémorisé*

### ■ ANNULATION TOTALE DES ÉMETTEURS

- Depuis l'émetteur:

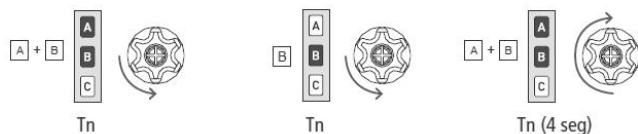

*Tn: émetteur déjà mémorisé*

- Depuis le câble auxiliaire (utiliser en cas d'urgence):

1. Couper le courant au moyen du disjoncteur.
2. Joindre le câble blanc au marron (phase) ou au bleu (neutre).
3. Alimenter le moteur.
4. Couper à nouveau le courant du moteur (4 secondes).
5. Remettre le courant sur le moteur. Après 4 secondes, le moteur effectue une brève rotation, puis une rotation plus longue en sens contraire.
6. Déconnecter le moteur du courant.
7. Séparer le câble blanc du marron/bleu. Isoler correctement le câble avant de connecter le courant.

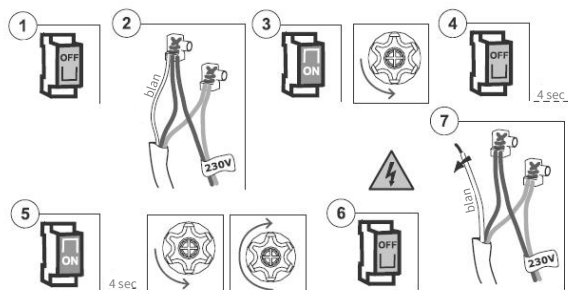

## (VII) Ajustage fins de course

### ▪ RÉGLAGE DE LA FIN DE COURSE DE FERMETURE

- Enrouler le store jusqu'à la position de fermeture.
- Le figer en appuyant sur "STOP" jusqu'à ce que le moteur fasse une rotation en descente.

Si le store est complètement fermé:

- Baisser d'environ 20 cm. Il peut être nécessaire d'utiliser le bouton de montée car le sens correct de rotation sera identifié seulement après avoir mémorisé la position de fermeture.
- Figurer la position en appuyant sur STOP jusqu'à ce que le moteur fasse une rotation en descente.

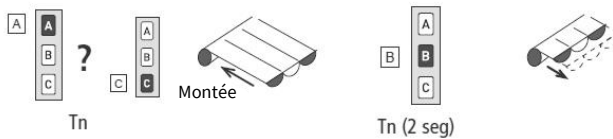

*Tn: émetteur déjà mémorisé*

### ▪ RÉGLAGE DE LA FIN DE COURSE D'OUVERTURE

- Porter le store jusqu'à la position d'ouverture en maintenant enfoncé le bouton de descente de l'émetteur.
- Figurer la position en maintenant enfoncé le bouton "STOP" pendant 2 secondes, jusqu'à ce que le moteur effectue une rotation en montée.

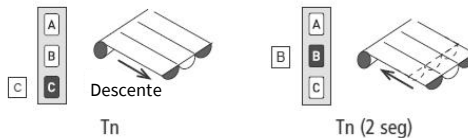

*Tn: émetteur déjà mémorisé*

■ ANNULLATION DE LA FIN DE COURSE DE FERMETURE

Appliquer la séquence suivante et procéder à nouveau au réglage de la fin de course de fermeture:

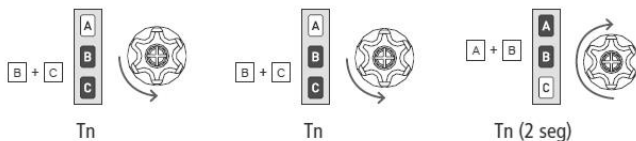

Tn: Émetteur déjà mémorisé

■ CANCELACIÓN DEL FIN DE CARRERA DE APERTURA

Appliquer la séquence suivante et procéder à nouveau au réglage de la fin de course d'ouverture:

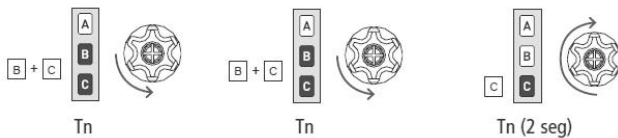

Tn: Émetteur déjà mémorisé

■ ANNULLATION TOTALE DES FINS DE COURSE

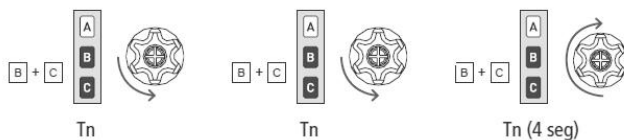

Tn: Émetteur déjà mémorisé

## (VIII) Fonctions avancées

### ■ POSITION INTERMÉDIAIRE

- Mémorisation position intermédiaire:
  - Positionner le store sur la position favorite.
  - Appuyer sur "STOP" pendant 4 secondes jusqu'à confirmation du moteur.
  - Une fois mémorisée, pour mettre le store dans cette position, appuyer sur "STOP" pendant 2 secondes.

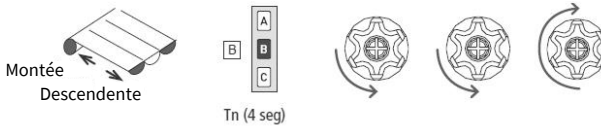

*Tn: émetteur déjà mémorisé*

### - Position intermédiaire supplémentaire:

- Position utile pour que le store s'ouvre automatiquement au moyen du capteur WindTec Lux.
- Pour régler la position, mémoriser d'abord les fins de course puis exécuter la séquence suivante.

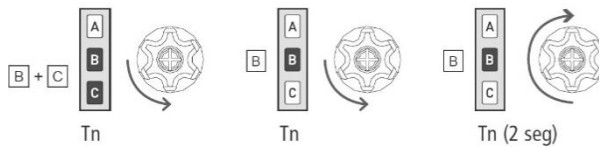

*Tn: émetteur déjà mémorisé*

- Le moteur est désormais en mode "Homme présent", et permet d'exécuter cette position avec précision.
- Actionner le store jusqu'à la position d'ouverture souhaitée.
- Appuyer sur B pendant 2 secondes jusqu'à ce que le moteur confirme.

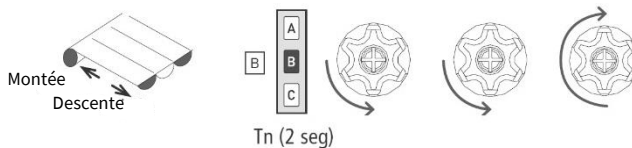

- Lorsque WindTec Lux actionne l'ouverture avec l'automatisme lumière, le store se mettra dans la position intermédiaire supplémentaire.

- *Annulation position intermédiaire:*
  - o Effectuer l'annulation si l'on ne souhaite pas disposer de cette fonction, et pour modifier la position intermédiaire déjà mémorisée.
  - o AVANT D'ANNULER, porter le store sur cette position intermédiaire en appuyant sur STOP pendant 2 secondes.
  - o Appuyer sur "STOP" pendant 4 secondes jusqu'à ce que le moteur effectue le signal de confirmation.

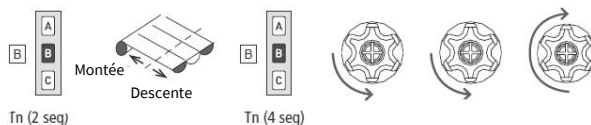

Tn: émetteur déjà mémorisé

■ RÉGLAGE DE LA FORCE DE FERMETURE

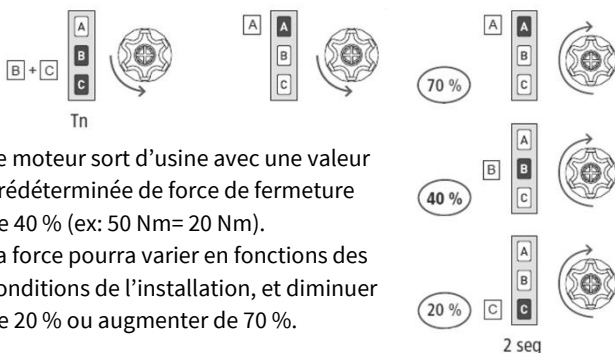

Le moteur sort d'usine avec une valeur prédéterminée de force de fermeture de 40 % (ex: 50 Nm= 20 Nm).

La force pourra varier en fonctions des conditions de l'installation, et diminuer de 20 % ou augmenter de 70 %.



## ■ POSITION TENSION TOILE

Cette fonction permet, en position ouverte, que le moteur effectue un retour automatique de l'amplitude programmée, pour tendre la toile. Cette position doit être programmée après avoir mémorisé les fins de course.

- Début de la procédure de mémorisation de la position optionnelle:

Cette séquence permet un réglage millimétrique de la tension, car il porte le store en position d'ouverture maximale et prépare le moteur pour le fonctionnement en mode "HOMME PRÉSENT".

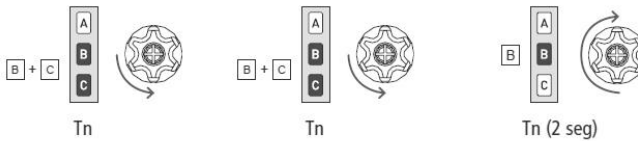

*Tn: émetteur déjà mémorisé*

- Réglage et validation de la position optionnelle:

Après le réglage et la confirmation de la position, le store effectue une ouverture en position maximale, et un retour à la nouvelle position.

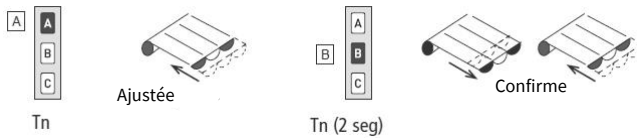

*Tn: émetteur déjà mémorisé*

- Effacement de la position optionnelle:

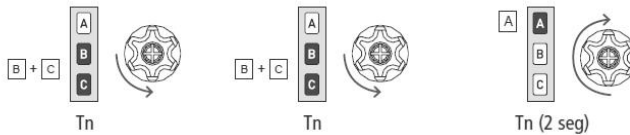

*Tn: émetteur déjà mémorisé*

### ▪ GESTION MODALITÉ DE COMMANDE

Il y a trois configurations possibles. Pour passer d'une configuration à une autre, répéter la séquence jusqu'à arriver à la configuration souhaitée. Elles sont disponibles dans l'ordre suivant:

- Montée-arrêt-descente-arrêt (par défaut).
- Montée-arrêt (pour deux boutons indépendants).
- Montée-descente avec "homme présent" (pour deux boutons indépendants).

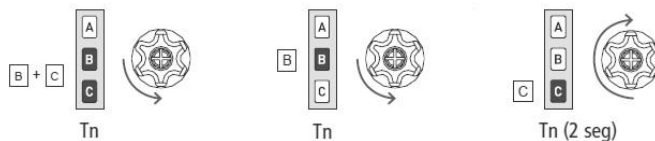

*Tn: émetteur déjà mémorisé*

### ▪ GESTION SUPER-SENSIBILITÉ DANS LA DÉTECTION D'OBSTACLES EN DESCENTE

Si nécessaire, il est possible d'activer/désactiver une sensibilité très élevée dans la détection d'obstacles en descente.

- Activer la fonction:

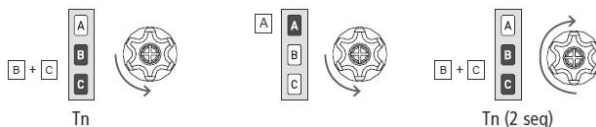

- Désactiver la fonction:

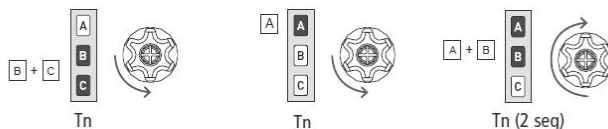

*Tn: émetteur déjà mémorisé*

## MAINTENANCE

Pour un bon usage et une plus longue durée de vie, il est recommandé d'effectuer une maintenance et des révisions périodiques au moins une fois par an, ou plus souvent, en fonction de la fatigue due au vent sur le lieu d'installation. Pour prévenir la corrosion, il est recommandé de nettoyer périodiquement les goulotte et les profils avec un savon neutre. La fréquence minimum est une fois par an, mais doit être augmentée pour les profils exposés à des environnements agressifs (marins, industriels, présence de poussière en suspension, etc.). Il est important de rincer abondamment à l'eau après avoir utilisé des détergents pour éviter la formation de sels sur la surface des profils. Ce nettoyage périodique, s'il est bien réalisé, élimine de la surface des profils les agents exogènes susceptibles d'attaquer le revêtement et l'aluminium, ce qui prolonge la durée de vie des profils et leurs prestations esthétiques. Pour le nettoyage de la toile, il est recommandé d'éliminer la poussière accumulée à sec afin de pouvoir retirer toutes les particules de la surface par aspiration, insufflation d'air, frappage ou brossage. Pour éliminer des taches de doigts ou de graisse, utiliser un savon neutre. S'il s'agit de taches aqueuses, nettoyer avec une éponge, au plus, et frotter avec un chiffon humide. Ne JAMAIS utiliser de détergents ni d'autres produits chimiques. Enfin, vérifier le serrage des vis selon les couples de serrage.

Les opérations d'installation et de mise en marche, de réglage et de maintenance obligatoire doivent être effectuées par des techniciens spécialisés.

Toutes les opérations seront effectuées en conditions de sécurité après avoir coupé le courant du système.

Il est recommandé de faire bouger périodiquement le produit (extension complète et enroulement complet) et de vérifier les composants fonctionnent correctement. Ne pas laisser le produit sans mouvement pendant trop longtemps.

## TOILE

Le nettoyage de la toile est nécessaire pour la protéger de la formation de moisissures, et pour retarder sa saleté permanente. Pour ce faire, nous recommandons:

- Au moins deux fois par an, inspecter son état.
- Si nécessaire, nettoyer avec un aspirateur et avec une éponge ou un chiffon humide, à l'aide d'eau tiède et de produits non agressifs, comme du savon neutre.

Pour le nettoyage en conditions de sécurité, étendez le store, déconnectez l'alimentation électrique et nettoyez la partie visible de la toile. Suivez les instructions, et en cas de doute, contactez votre distributeur.

## DÉMONTAGE ET ÉLIMINATION

Le démontage du produit en fin de vie utile devra être effectué par du personnel qualifié, avec toutes les caractéristiques de sécurité observées lors de l'installation.

Pour démonter ce produit, suivre en ordre inverse les étapes de montage, en prenant plusieurs précautions. Pour plus d'informations sur ces instructions de démontage, reportez-vous aux chapitres d'installation de ce manuel, qui présentent des schémas et des informations détaillées.

Nous vous conseillons de recycler l'emballage du produit de manière responsable:

- Triez les déchets en séparant chacun des matériaux pour procéder à une élimination efficace de l'emballage.
- N'éliminez pas les matériaux d'emballage avec les autres types de déchets. Portez-les vers un centre de tri de matériaux d'emballage désigné par les autorités locales.
- Pour réduire au minimum l'impact environnemental des emballages et des déchets d'emballages, il est nécessaire de définir la composition et la nature de l'emballage de nos produits pour recommander leur meilleure élimination.

- **Papier et carton:** dans la gestion des déchets, le recyclage du papier et du carton revêt une grande importance, car 70% sont récupérés. L'élimination du papier et du carton peut se faire par différentes voies, comme le ramassage par des opérateurs privés, ou la livraison à des centres de traitements de déchets,
- **Plastique:** le recyclage de plastiques a de nombreux avantages pour l'environnement, et donc, des bienfaits sur la qualité de vie de tous, ce qui contribue à une grande économie de matières premières, de ressources naturelles, énergétiques et économiques. L'élimination du plastique peut se faire à travers des opérateurs privés ou en les livrant à des centres de traitements des déchets.
- **Film alvéolaire:** il est composé de polyéthylène basse densité, ce qui en fait un matériau 100 % recyclable. Pour son élimination optimale, mener les résidus de ce matériau à une centrale de traitement de déchets plastiques.
- **Équipements électriques, électroniques et appareils électriques et électroniques:** ils ne doivent pas être éliminés mélangés à d'autres types de déchets. Ils peuvent être livrés à des centres spécifiques, régulés par les administrations locales.
- **Textile:** la réutilisation des déchets textiles est indispensable. La réutilisation contribue à réduire la consommation d'eau et les gaz générés dans le processus de fabrication. Pour favoriser l'élimination appropriée des textiles, il est recommandé de les déposer dans un centre de déchets spécialisé, où les différentes fibres textiles seront séparées.

Agissez selon les recommandations pour un recyclage efficace des produits. Souvenez-vous que recycler est plus qu'une action, c'est la valeur de la responsabilité choice to preserve our natural resources.

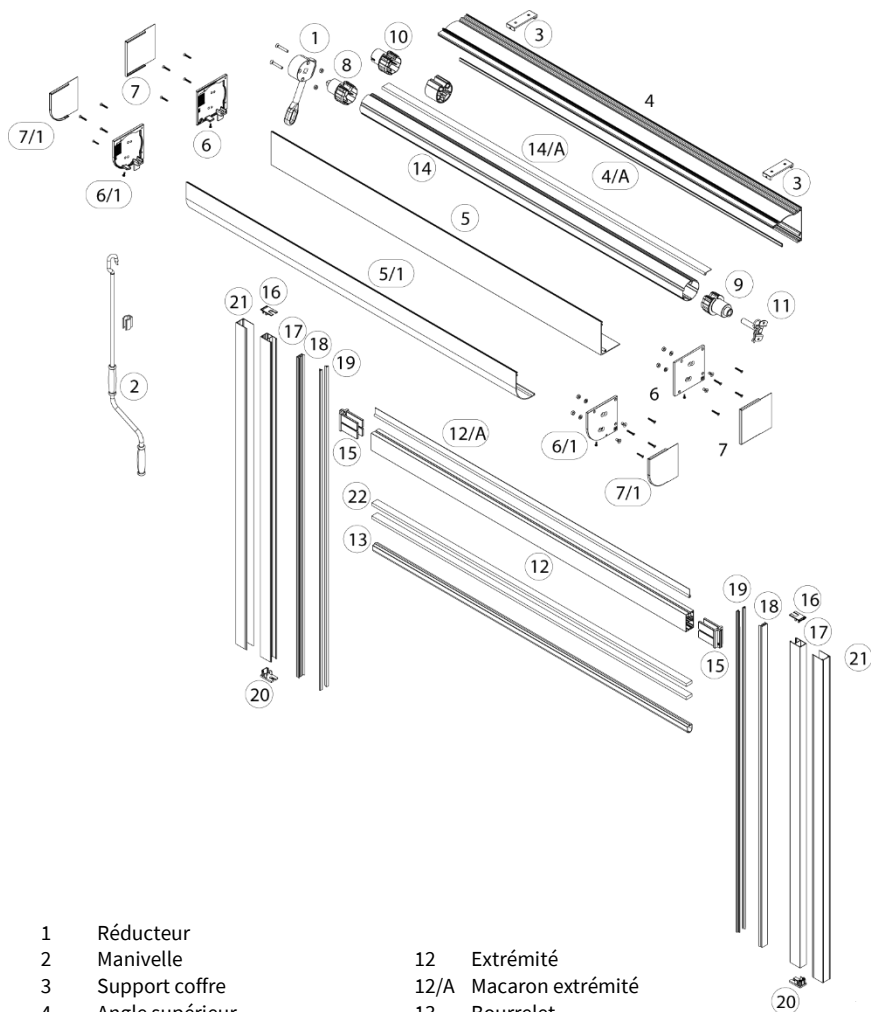

- |     |                         |      |                          |
|-----|-------------------------|------|--------------------------|
| 1   | Réducteur               | 12   | Extrémité                |
| 2   | Manivelle               | 12/A | Macaron extrémité        |
| 3   | Support coffre          | 13   | Bourrelet                |
| 4   | Angle supérieur         | 14   | Axe                      |
| 5   | Trappe coffre Ágora     | 14/A | Macaron axe              |
| 5/1 | Trappe coffre Aura      | 15   | Bouchon extrémité        |
| 6   | About Ágora             | 16   | Entonnoir pour glissière |
| 6/1 | About Aura              | 17   | Glissière                |
| 7   | Enjoliveur about Ágora  | 18   | Coulisse intérieure ZIP  |
| 7/1 | Enjoliveur about Aura   | 19   | Coulisse extérieure ZIP  |
| 8   | Coussinet               | 20   | Pied accroche coulisse   |
| 9   | Coussinet creux         | 21   | Coulisse de compensation |
| 10  | Coussinet moteur        | 22   | Platine extrémité        |
| 11  | Plaque H30 axe amovible |      |                          |

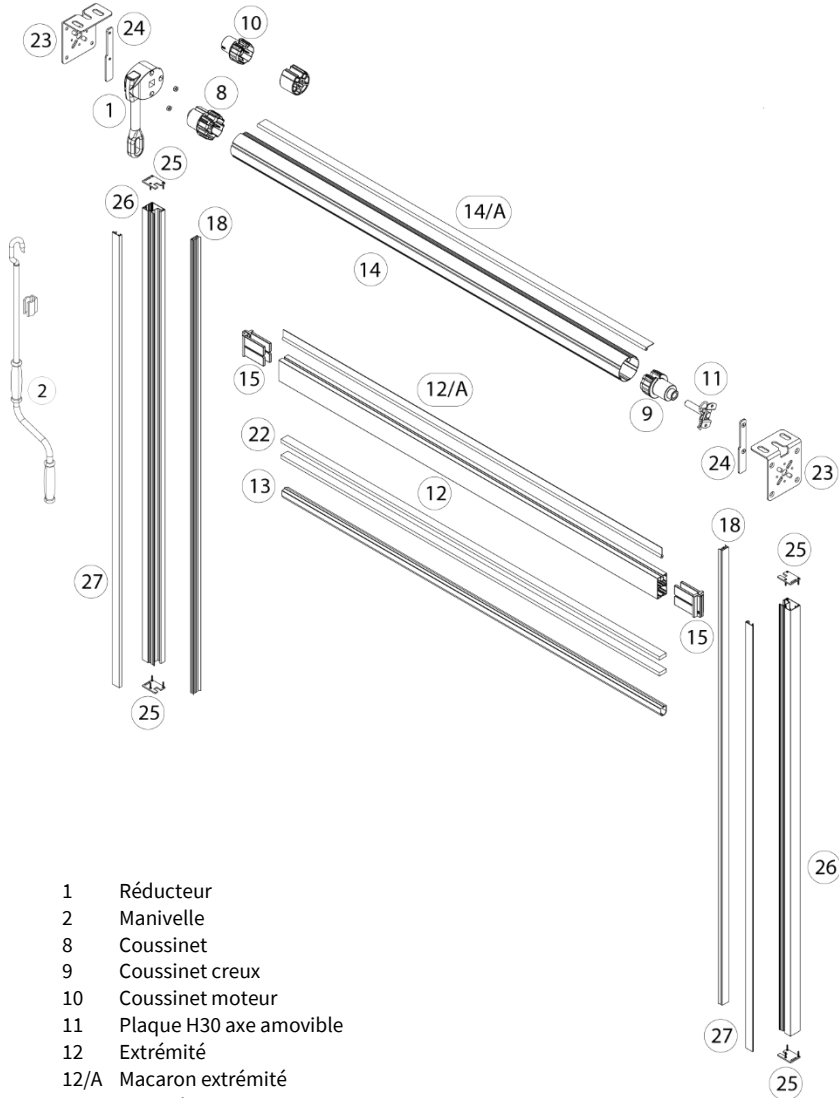

- |      |                         |    |                    |
|------|-------------------------|----|--------------------|
| 1    | Réducteur               | 24 | Goujon             |
| 2    | Manivelle               | 25 | Entonnoir coulisse |
| 8    | Coussinet               | 26 | Coulisse           |
| 9    | Coussinet creux         | 27 | Cache coulisse     |
| 10   | Coussinet moteur        |    |                    |
| 11   | Plaque H30 axe amovible |    |                    |
| 12   | Extrémité               |    |                    |
| 12/A | Macaron extrémité       |    |                    |
| 13   | Bourrelet               |    |                    |
| 14   | Axe                     |    |                    |
| 14/A | Macaron axe             |    |                    |
| 15   | Bouchon extrémité       |    |                    |
| 18   | Coulisse intérieure ZIP |    |                    |
| 22   | Platine extrémité       |    |                    |
| 23   | Support Nuvola          |    |                    |

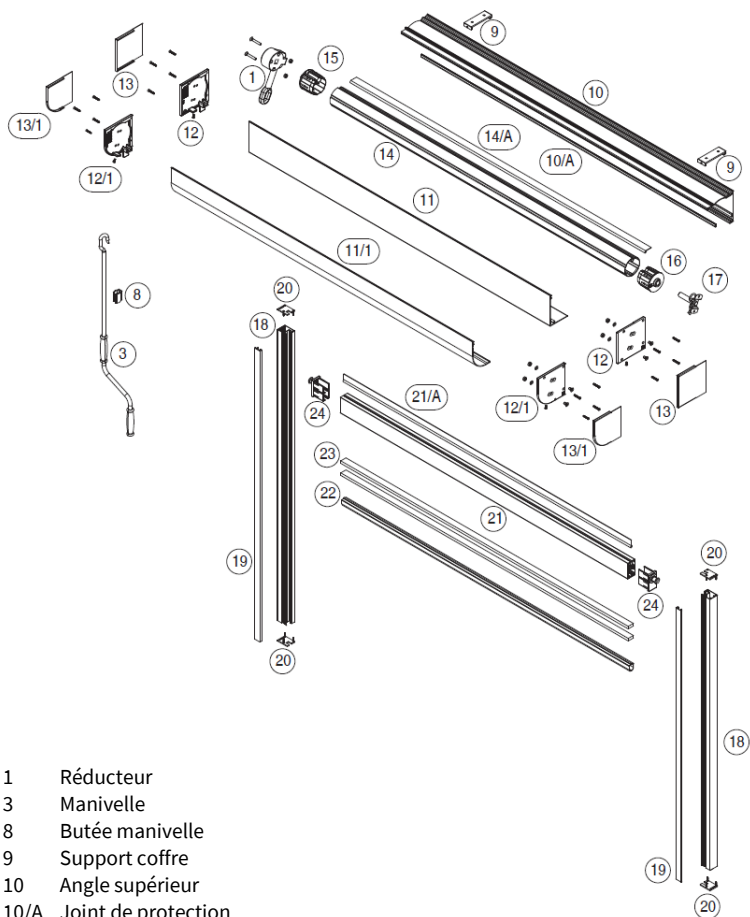

- |      |                          |      |                   |
|------|--------------------------|------|-------------------|
| 1    | Réducteur                | 18   | Coulisse          |
| 3    | Manivelle                | 19   | Cache coulisse    |
| 8    | Butée manivelle          | 20   | Pied coulisse     |
| 9    | Support coffre           | 21   | Extrémité         |
| 10   | Angle supérieur          | 21/A | Macaron extrémité |
| 10/A | Joint de protection      | 22   | Bourrelet         |
| 11   | Trappe coffre Ágora      | 23   | Platine           |
| 11/1 | Trappe coffre Aura       | 24   | Bouchon extrémité |
| 12   | About Ágora              |      |                   |
| 12/1 | About Aura               |      |                   |
| 13   | Enjoliveur about Ágora   |      |                   |
| 13/1 | Enjoliveur about Aura    |      |                   |
| 14   | Axe                      |      |                   |
| 14/A | Macaron axe              |      |                   |
| 15   | Coussinet avec axe 13x20 |      |                   |
| 16   | Coussinet creux Ø14      |      |                   |
| 17   | Plaque H30 axe amovible  |      |                   |



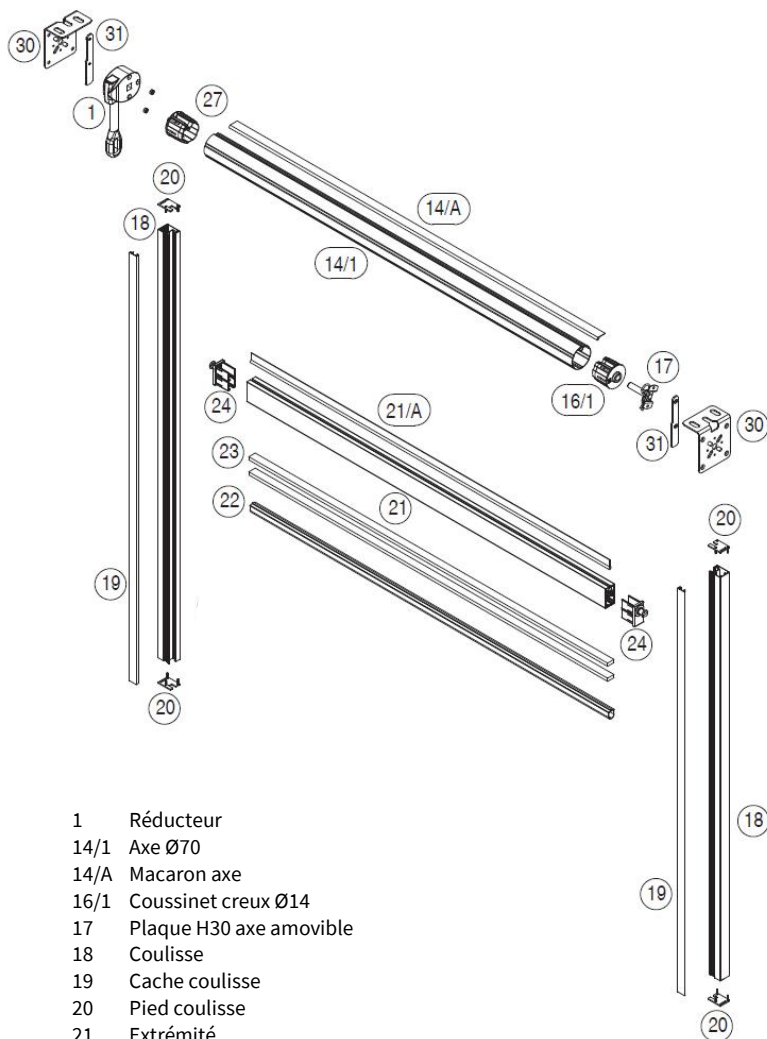

- 1 Réducteur
- 14/1 Axe Ø70
- 14/A Macaron axe
- 16/1 Coussinet creux Ø14
- 17 Plaque H30 axe amovible
- 18 Coulisse
- 19 Cache coulisse
- 20 Pied coulisse
- 21 Extrémité
- 21/A Macaron extrémité
- 22 Bourrelet
- 23 Platine
- 24 Bouchon extrémité

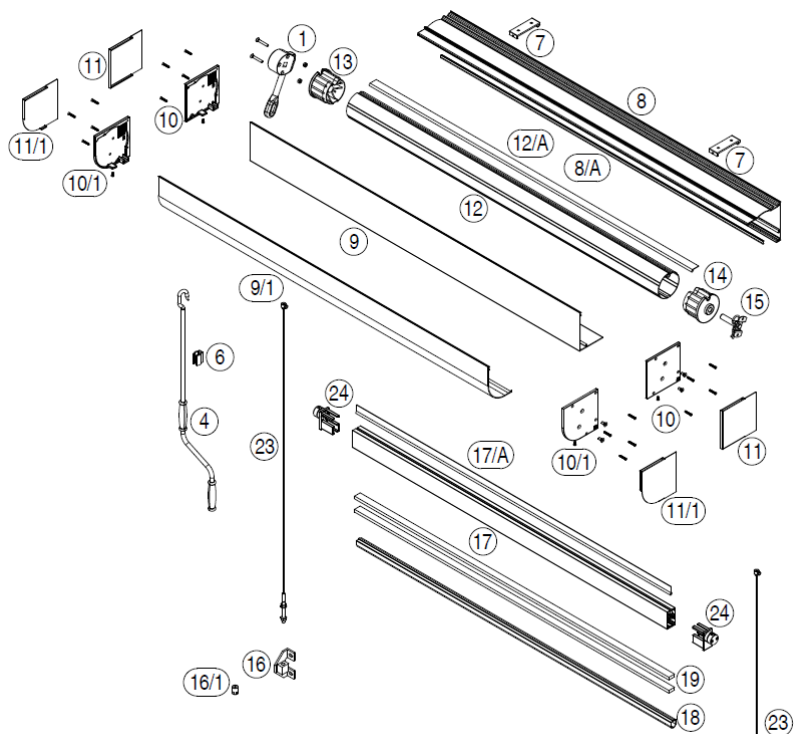

- |      |                          |  |  |
|------|--------------------------|--|--|
| 1    | Réducteur                |  |  |
| 4    | Manivelle                |  |  |
| 6    | Butée manivelle          |  |  |
| 7    | Support coffre           |  |  |
| 8    | Angle supérieur          |  |  |
| 8/A  | Joint de protection      |  |  |
| 9    | Trappe Ágora             |  |  |
| 9/1  | Trappe Aura              |  |  |
| 10   | About Ágora              |  |  |
| 10/1 | About Aura               |  |  |
| 11   | Enjoliveur about Ágora   |  |  |
| 11/1 | Enjoliveur about Aura    |  |  |
| 12   | Axe                      |  |  |
| 12/A | Macaron axe              |  |  |
| 13   | Coussinet avec axe 13x20 |  |  |
| 14   | Coussinet creux Ø14      |  |  |
| 15   | Plaque H30 axe amovible  |  |  |
| 16   | Support tige/câble       |  |  |
| 16/1 | Support câble inox       |  |  |
| 17   | Extrémité                |  |  |
| 17/A | Macaron extrémité        |  |  |
| 18   | Bourrelet                |  |  |
| 19   | Platine                  |  |  |
| 23   | Câble inox Ø4 mm         |  |  |
| 24   | Bouchon extrémité        |  |  |

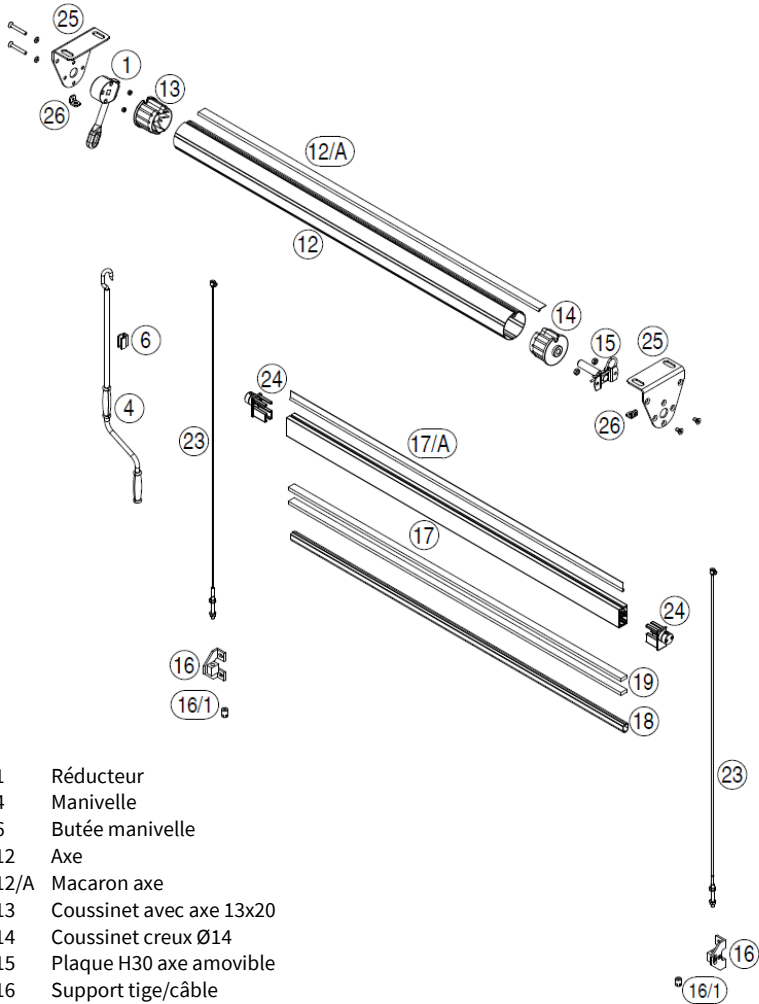

- 1 Réducteur
- 4 Manivelle
- 6 Butée manivelle
- 12 Axe
- 12/A Macaron axe
- 13 Coussinet avec axe 13x20
- 14 Coussinet creux Ø14
- 15 Plaque H30 axe amovible
- 16 Support tige/câble
- 16/1 Support câble inox
- 17 Extrémité
- 17/A Macaron extrémité
- 18 Bourrelet
- 19 Platine
- 23 Câble inox Ø4 mm
- 24 Bouchon extrémité
- 25 Support Nuvola câble/tige
- 26 Support tige/câble

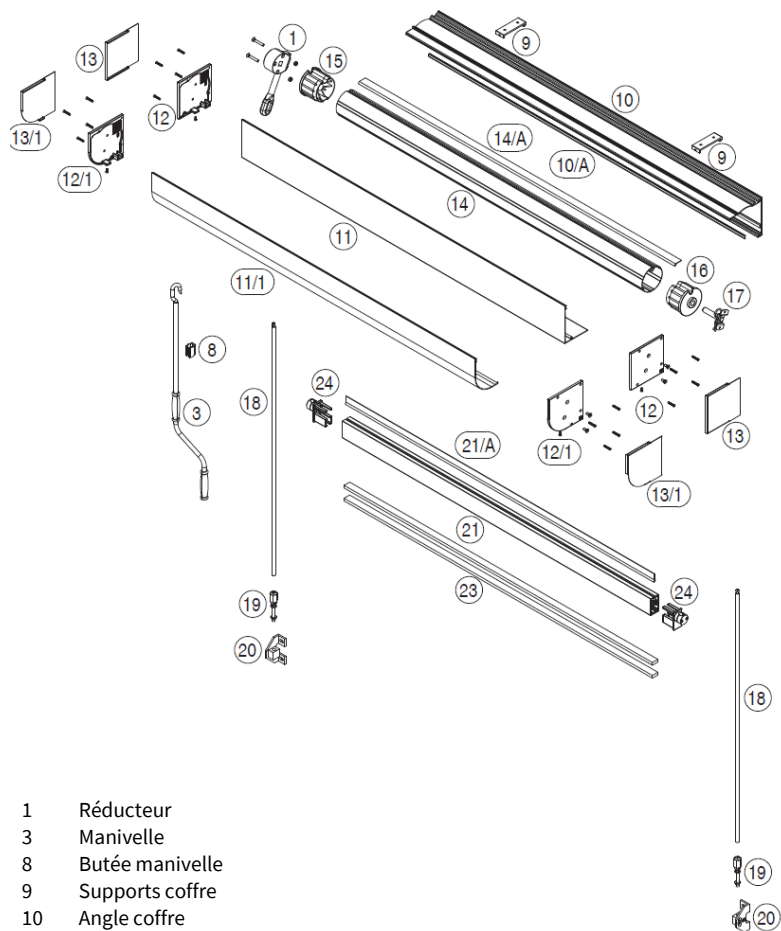



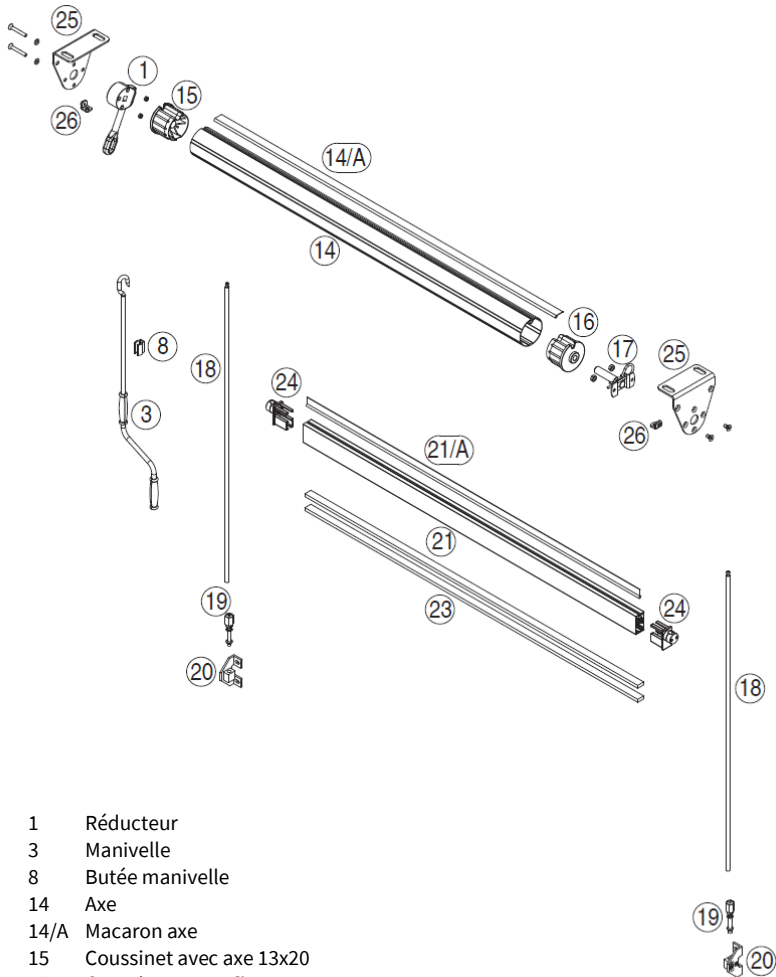















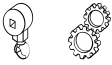

- |      |                          |      |                    |
|------|--------------------------|------|--------------------|
| 1    | Réducteur                | 18   | Tige inox Ø10 mm   |
| 3    | Manivelle                | 19   | Tenseur pour tige  |
| 8    | Butée manivelle          | 20   | Support tige/câble |
| 9    | Supports coffre          | 21   | Extrémité          |
| 10   | Angle coffre             | 21/A | Macaron extrémité  |
| 10/A | Joint de protection      | 23   | Platine            |
| 11   | Trappe Ágora             | 24   | Bouchon extrémité  |
| 11/1 | Trappe Aura              |      |                    |
| 12   | About Ágora              |      |                    |
| 12/1 | About Aura               |      |                    |
| 13   | Enjoliveur about Ágora   |      |                    |
| 13/1 | Enjoliveur about Aura    |      |                    |
| 14   | Axe                      |      |                    |
| 14/A | Macaron axe              |      |                    |
| 15   | Coussinet avec axe 13x20 |      |                    |
| 16   | Coussinet creux Ø14      |      |                    |
| 17   | Plaque H30 axe amovible  |      |                    |

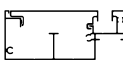
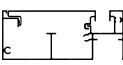

- 1 Réducteur
- 3 Manivelle
- 8 Butée manivelle
- 14 Axe
- 14/A Macaron axe
- 15 Coussinet avec axe 13x20
- 16 Coussinet creux Ø14
- 17 Plaque H30 axe amovible
- 18 Tige inox Ø10 mm
- 19 Tenseur tige inox
- 20 Support tige/câble
- 21 Extrémité
- 21/A Macaron extrémité
- 23 Platine
- 24 Bouchon extrémité
- 25 Support Nuvola
- 26 Support tige/câble





















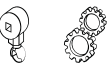



(R1)

# ÁGORA

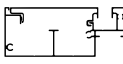
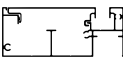
Dimensions	110				130			
Système								
Automatisme								
Compatibilité coulisses			-				-	
(Ancrage)								
			-				-	
			-				-	
			-				-	
			-				-	

COMBINAISONS

# AURA

Dimensions	110				130				150
Système									
Automatisme									
Compatibilité coulisses			-				-		
(Ancrage)									
			-				-		
			-				-		
			-				-		
			-				-		



Dimensions	110				130			
Système								
Automatisme								
Compatibilité coulisses			-				-	
(Ancrage)								

--	--	--	--	--	--	--	--	--

## PROBLÈMES, CAUSES ET SOLUTIONS

PROBLÈMES	CAUSES	SOLUTIONS
La toile se déplace vers un côté	Store mal nivelé	Nivelier correctement
L'extrémité ne descend pas	Protection thermique du moteur	Placer les coulisses correctement
Le moteur ne fonctionne pas après plusieurs minutes de fonctionnement continu	Protection thermique du moteur	Laisser refroidir le moteur quelques minutes
Le moteur est très bruyant	Défaillance du moteur	Intervention technique nécessaire
Le moteur ne bouge pas	Erreur de câblage	Vérifier le circuit électrique selon les diagrammes
	Défaillance du moteur	Vérifier le moteur et le remplacer si nécessaire



## INTRODUÇÃO

Informação preliminar  
Avisos sobre a utilização  
Responsabilidade  
Requisitos do utilizador e do instalador

---

## INSTALAÇÃO E ENTRADA EM FUNCIONAMENTO

Instalação  
Entrada em funcionamento  
Motorização e Automatismos  
Manutenção/Desmontagem e eliminação

---

## DIAGRAMA DE PEÇAS COMBINAÇÕES

---

## PROBLEMAS, CAUSAS E SOLUÇÕES

---

## INFORMAÇÃO PRELIMINAR



### **This manual shall not be modified.**

Dirige-se a quem vai utilizar o sistema de queda vertical (doravante toldo), tal como o instalador, o encarregado da manutenção, o proprietário e o utilizador, e constitui o instrumento essencial para os corretos uso e manutenção do produto. As instruções relativas ao manuseamento, desembalagem, instalação e entrada em funcionamento, regulação e manutenção dirigem-se ao instalador. As instruções relativas aos modos corretos de uso e manutenção, bem como a garantia, dirigem-se ao proprietário.

Este manual de utilização é parte integrante do produto e essencial para a validade da garantia. Conserve-o integralmente e num local facilmente acessível, e mantenha-o sempre à disposição do pessoal qualificado encarregado da instalação, manutenção ou regulação para permitir a realização dos registos necessários.

### AVISOS SOBRE A UTILIZAÇÃO

- Leia atentamente as instruções do manual seguinte.
- Antes da instalação, verifique se o toldo se encontra em perfeitas condições.
- Certifique-se de que o local da instalação cumpre as medidas de segurança.
- A instalação deve ser efetuada por pessoal qualificado.
- O fabricante não se responsabiliza pelos danos provocados por maus tratos ou por uma má instalação do produto.
- O produto cumpre a norma EM 13561 Toldos. Requisitos de prestações incluindo a segurança e *EM 1932 Gelosias exteriores e estores. Resistência às cargas de vento. Método de ensaio e critérios de prestações*. Saiu da fábrica em perfeitas condições.
- É preciso dispor das ferramentas e da roupa adequada para a instalação, tal como luvas, óculos de proteção e calçado de segurança.
- Se o modelo dispuser de motor elétrico, leia atentamente as instruções do fabricante antes da sua instalação.

## RESPONSABILIDADE

O fabricante não se responsabiliza pelos danos ocasionados a pessoas ou à própria instalação, devido ao incumprimento das instruções registadas neste manual sobre a instalação, o uso e a manutenção. Também devido a ações violentas ou manobras incorretas e por modificações efetuadas sem autorização por escrito.

Para as operações de manutenção ou reparação dever-se-ão utilizar exclusivamente peças sobressalentes originais. O produto é garantido de acordo com os acordos estipulados na venda. Por isso, a garantia e a marcação CE caducarão em caso de inobservância das normas e instruções de utilização proporcionadas neste manual.

## REQUISITOS DO UTILIZADOR E DO INSTALADOR

Estes sistemas são exclusivamente destinados ao uso para o qual foram concebidos. Qualquer outro uso é inadequado e, portanto, perigoso. Em caso algum se deverá instalar um produto deteriorado dado poder provocar danos à própria instalação, bem como criar situações perigosas.

**A instalação deve sempre ser realizada por um instalador profissional. Em caso de dúvidas ou de um uso imprevisto, entre em contacto com LaViuda antes da instalação.**

## AURA / ÁGORA ZIP

### INSTALAÇÃO DA CAIXA

Verificar a montagem da caixa e introduzir as guias interiores nos cabeçotes até estarem alinhadas.

Colocar na sua posição:

- (G) Instalação em interior oco.
- (H) Instalação no exterior fachada.
- (I) Instalação autossustentada.

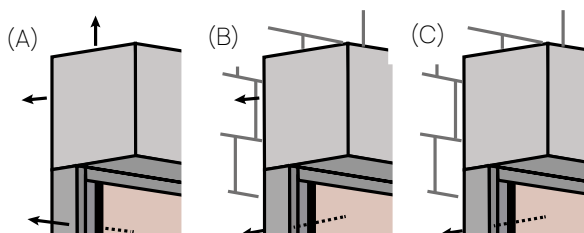
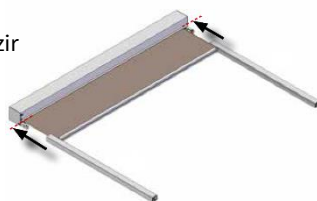

### INSTALAÇÃO DA CAIXA COM SUPORTES

Fixar os respetivos suportes dependendo de a montagem ser no teto ou na parede, seguindo o esquema de instalação e utilizando os sistemas de fixação recomendados.

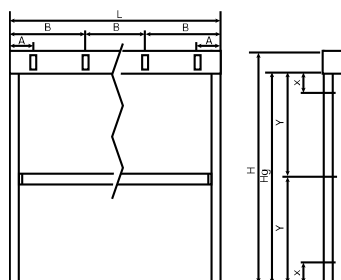

(ESQUEMA DE INSTALAÇÃO)

L		A	B	H		X	Y
suportes				orifício de fixação			
0-1500	2	150	-	0-1000	2	90	-
1501-3000	3	150	L/2	1001-2000	3	90	Hg / 2
3001-4000	4	150	L/3	2001-2500	4	90	Hg / 3
4001-5000	5	150	L/4	3001-4000	5	90	Hg/4
5001-6500	6	150	L/5	4001-5000	6	90	Hg/5
6501-8000	7	150	L/6	5001-6000	7	90	Hg/6

SISTEMAS DE FIXAÇÃO RECOMENDADOS		
HSL-3-SK		BETÃO
Hilti HRD-U10 Hilti HRD-S10		BETÃO TIJOLO PERFURADO TIJOLO MACIÇO
HUD-1 HUD-L		

*Em ambientes corrosivos, é recomendável usar fixações de aço inoxidável*

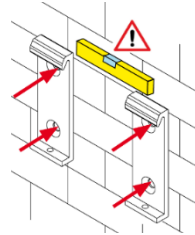

## Sequência operacional da colocação das fixações:

FIXAÇÃO MECÂNICA		FIXAÇÃO QUÍMICA	
	1 Faça um orifício com a broca apropriada para o tipo de fixação.		1 Faça um orifício com a broca apropriada para o tipo de fixação.
	2 Preste atenção à profundidade de execução do orifício.		2 Preste atenção à profundidade de execução do orifício.
	3 Retire a poeira e os fragmentos do orifício (o ideal é usar ar comprimido).		3 Retire a poeira e os fragmentos do orifício com uma escova.
	4 Instale a fixação.		4 Retire o pó residual com ar comprimido.
	5 Aperte até conseguir o binário de aperto recomendado (consulte o catálogo Hilti).		5 Injete o adesivo químico.
	6 Configuração final.		6 Insira e ajuste a fixação respeitando o tempo de descanso antes de colocar a placa (consulte o cartucho do produto).
			7 Coloque a placa e aperte até ao binário de aperto recomendado (consulte o catálogo da Hilti).

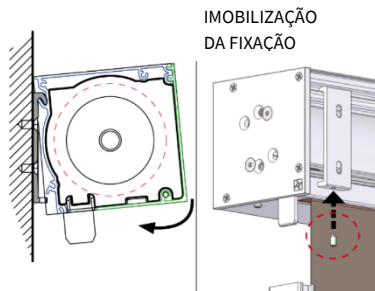

IMOBILIZAÇÃO DA FIXAÇÃO

**Fixação à parede:** Coloque a caixa na respetiva posição e fixe-a pela parte posterior.

**Fixação no teto:** retire a tampa para aceder ao suporte. Coloque a caixa sobre as abas do suporte e fixe-o aparafusando o parafuso sem cabeça do suporte sobre o perfil.

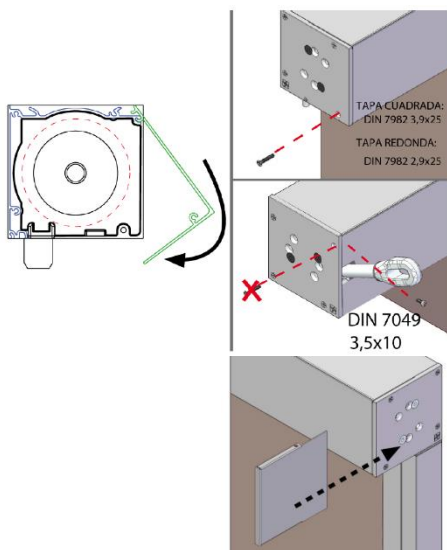
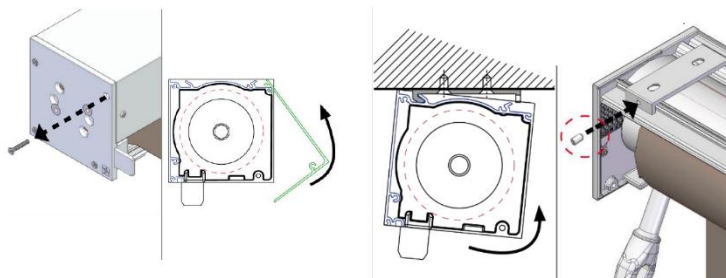

\*Na instalação do interior oco, a tampa deve ser fixada pelo lado interior, nunca lateralmente, a fim de permitir a sua abertura posterior.

Pôr as tampas. Deslizar as tampas de adorno sobre os cabeçotes laterais (se for o caso).

## INSTALAÇÃO DAS GUIAS

Colocar as tampas nas guias e fixá-las com parafusos DIN 7982 3,5x25. Introduzir as guias de forma a ficarem niveladas com os cabeçotes.

Colocar na posição, seja esta interior oco, exterior fachada ou encastrada, seguindo o esquema de montagem anterior.

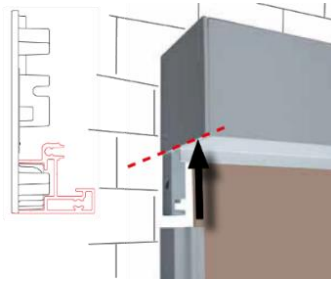

Depois de se colocarem as guias, descer completamente o toldo e verificar se estão niveladas. Depois, fechar o toldo e fixar as guias.

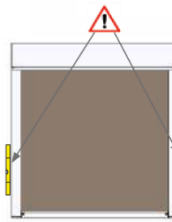

Abertura do toldo e nivelamento de guias



Aparafusar as guias com parafusos DIN 7981 M3, 9x16 de acordo com a posição seguinte:

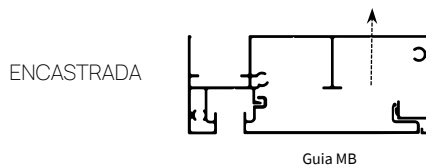
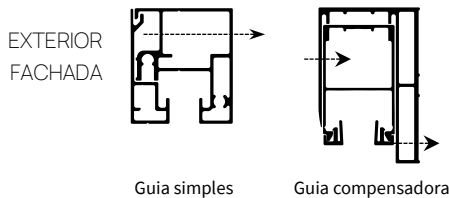
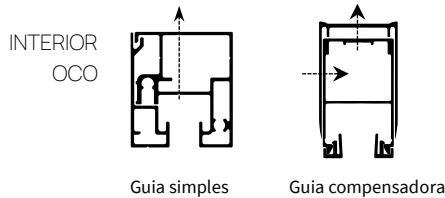



Com o toldo na parte superior, introduza a guia interior ZIP no fecho de correr do tecido.

Depois de colocada, insira à pressão a cobertura (A) da guia.

\*Para as guias compensadoras, depois de fixas, introduzir as guias ZIP de forma a ficarem alojadas nelas, e colocar as guias exteriores (B) à pressão. Recomenda-se descer o toldo uns centímetros para facilitar a instalação das guias.

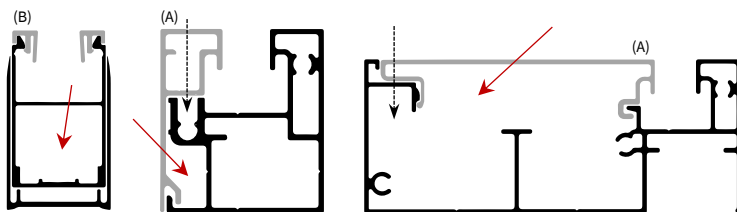

#### REGULAÇÃO DO TOLDO

Ajuste os fins de curso do motor se for necessário. Para o correto funcionamento do toldo, subir e descer completamente o tecido várias vezes para o posicionar adequadamente.

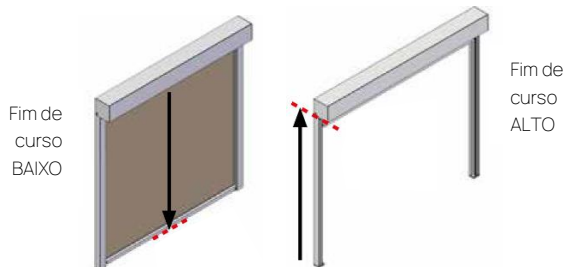

**A lona, uma vez estendida, pode apresentar rugas ou marcas por ter estado enrolada durante muito tempo. Isto NÃO é um problema, visto que estas marcas desaparecerão com o tempo devido às condições ambientais exteriores ao estabilizarem-se.**



## NUVOLA ZIP

### INSTALAÇÃO DOS CABEÇOTES

Una os pernos aos cabeçotes e coloque-os na posição. Introduza as guias interiores até ficarem niveladas. Fixar consoante a montagem:

- (G) Instalação em interior oco.
- (H) Instalação no exterior fachada.
- (I) Instalação autossustentada.

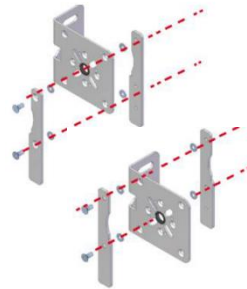

### SISTEMAS DE FIXAÇÃO RECOMENDADOS

HSL-3-SK		BETÃO
Hilti HRD-U10 Hilti HRD-S10		BETÃO TIJOLO PERFURADO
HUD-1 HUD-L		TIJOLO MACIÇO

*Em ambientes corrosivos, é recomendável usar fixações de aço inoxidável*

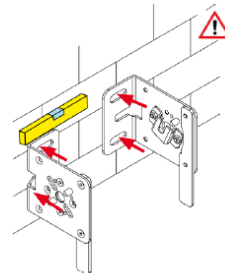

*\*Ver sequência do sistema de fixação na pág. 7*

Introduzir o cilindro e a respetiva junta no lado livre do eixo e colocar nos cabeçotes. Introduzir os pernos na cabeça do motor e no lado livre para fixá-lo.

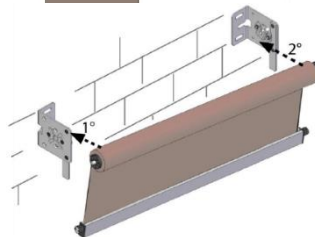
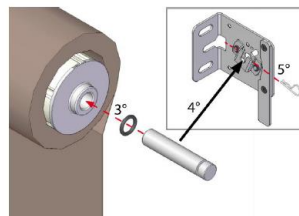

### INSTALAÇÃO DAS GUIAS

Colocar as tampas nas guias e fixá-las com parafusos DIN 7982 3,5x25.  
Introduzir as guias pelos pernos e observar se estão colocadas ao nível.

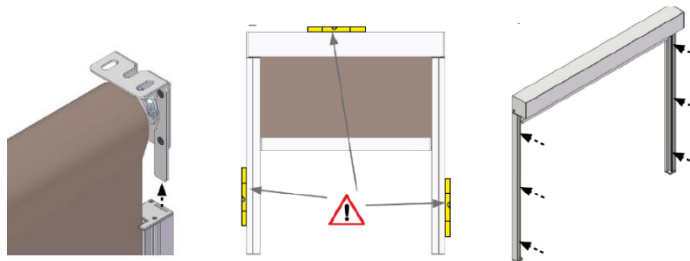

Colocar na posição, seja esta interior oco, exterior fachada ou encastrada, seguindo o esquema de montagem anterior. Aparafusar as guias com parafusos DIN 7981 M3, 9x16 de acordo com a posição seguinte:

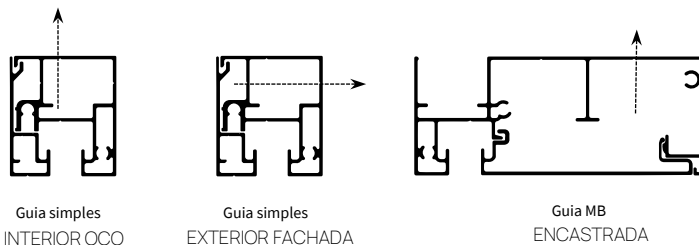

Quando as guias estiverem fixas na sua posição, introduza as guias interiores ZIP de tal forma que o fecho de correr fique no seu interior.

Fechar o conjunto com a cobertura da guia.

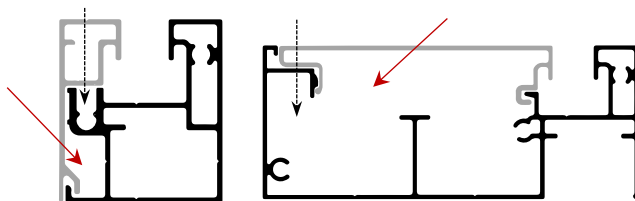

## REGULAÇÃO DO TOLDO

Ajuste os fins de curso do motor se for necessário. Para o correto funcionamento do toldo, subir e descer completamente o tecido várias vezes para o posicionar adequadamente.

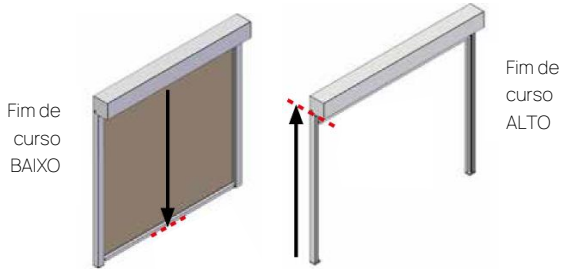

**A lona, uma vez estendida, pode apresentar rugas ou marcas por ter estado enrolada durante muito tempo. Isto NÃO é um problema, visto que estas marcas desaparecerão com o tempo devido às condições ambientais exteriores ao estabilizarem-se.**

## AURA / ÁGORA

## GUIA

## INSTALAÇÃO DA CAIXA

Coloque os cabeçotes na posição e introduza as guias interiores até ficarem niveladas. Fixar consoante a montagem:

- (D) Instalação em interior oco.
- (E) Instalação no exterior fachada.
- (F) Instalação autossustentada.

## INSTALAÇÃO DA CAIXA COM SUPORTES

Opcionalmente, a caixa pode ser segura por meio de suportes. Para fazer isso, devem ser colocados e fixos, garantindo que ficam nivelados.

(ESQUEMA DE INSTALAÇÃO)

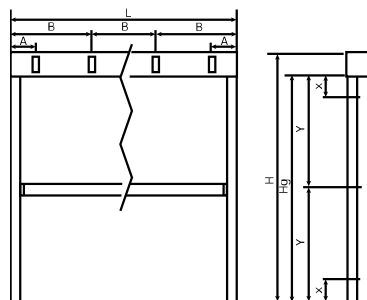

L		A	B	H		X	E
suportes				orifício de fixação			
0-1500	2	150	-	0-1000	2	90	-
1501-3000	3	150	L/2	1001-2000	3	90	Hg / 2
3001-4000	4	150	L/3	2001-3000	4	90	Hg / 3
4001-5000	5	150	L/4	3001-4000	5	90	Hg/4
				4001-5000	6	90	Hg/5

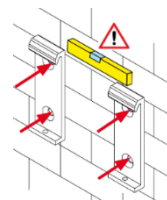

## SISTEMAS DE FIXAÇÃO RECOMENDADOS

HSL-3-SK		BETÃO
Hilti HRD-U10 Hilti HRD-S10		BETÃO TIJOLO PERFURADO TIJOLO MACIÇO
HUD-1 HUD-L		

*Em caso de ambientes corrosivos, é recomendável usar fixações de aço inoxidável*

*\*Ver sequência do sistema de fixação na pág.7*

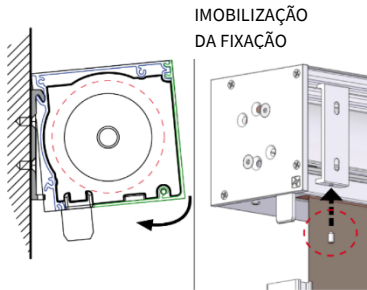

IMOBILIZAÇÃO  
DA FIXAÇÃO

**Fixação à parede:**  
coloque a caixa na  
respetiva posição e fixe-  
a pela parte posterior.

**Fixação no teto:** retire a tampa para aceder ao suporte. Coloque a caixa sobre as abas do suporte e fixe-o aparafusando o parafuso sem cabeça do suporte sobre o perfil.

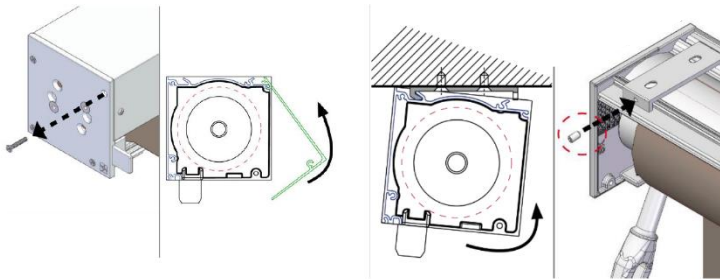

## INSTALAÇÃO DAS GUIAS

Colocar as tampas nas guias e fixá-las com parafusos DIN 7982 3,5x25.  
Introduzir as guias pelos pernos do cabeçote e observar se estão colocadas ao nível.

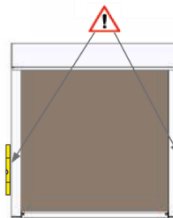
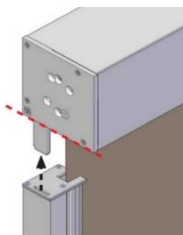

Abertura do toldo e  
nivelamento de guias



Fixação de  
guias

Colocar na posição, seja esta interior oco, exterior fachada ou encastrada, seguindo o esquema de montagem anterior. Aparafusar as guias com parafusos DIN 7981 M3,9x16.

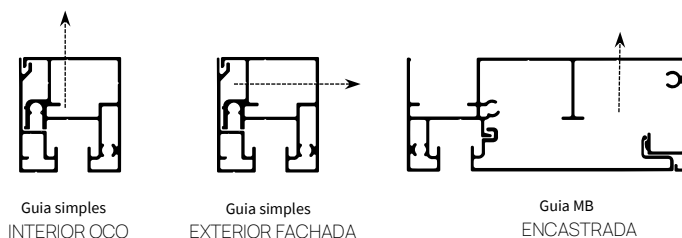

### REGULAÇÃO DO TOLDO

Ajuste os fins de curso do motor se for necessário. Para o correto funcionamento do toldo, subir e descer completamente o tecido várias vezes para o posicionar adequadamente.

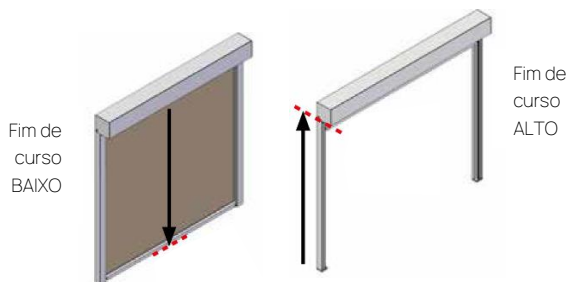

**A lona, uma vez estendida, pode apresentar rugas ou marcas por ter estado enrolada durante muito tempo. Isto NÃO é um problema, visto que estas marcas desaparecerão com o tempo devido às condições ambientais exteriores ao estabilizarem-se.**

## NUVOLA GUIA

### INSTALAÇÃO DOS CABEÇOTES

Una os pernos aos cabeçotes e coloque-os na posição. Introduza as guias interiores até ficarem niveladas. Fixar consoante a montagem:

- (G) Instalação em interior oco.
- (H) Instalação no exterior fachada.
- (I) Instalação autossustentada.

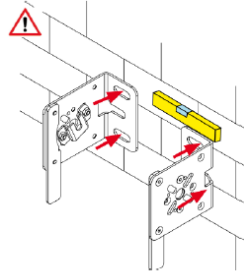

### SISTEMAS DE FIXAÇÃO RECOMENDADOS

HSL-3-SK		BETÃO
Hilti HRD-U10 Hilti HRD-S10		BETÃO TIJOLO PERFURADO
HUD-1 HUD-L		TIJOLO MACIÇO

*Em ambientes corrosivos, é recomendável usar fixações de aço inoxidável*

*\*Ver seqüência do sistema de fixação na pág.7*

Introduzir o cilindro com a junta no lado livre do eixo.

Colocar o eixo nos cabeçotes. Introduzir os pernos na cabeça do motor e no lado livre para fixá-lo.

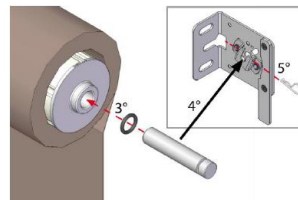
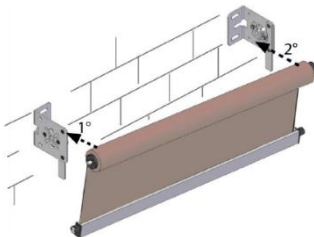

## INSTALAÇÃO DAS GUIAS

Colocar as tampas nas guias e fixá-las com parafusos DIN 7982 3,5x25. Introduzir as guias pelos pernos do cabeçote e observar se estão colocadas ao nível. Colocar na posição, seja esta interior oco, exterior fachada ou encastrada, seguindo o esquema de montagem anterior. Aparafusar as guias com parafusos DIN 7981 M3,9x16.

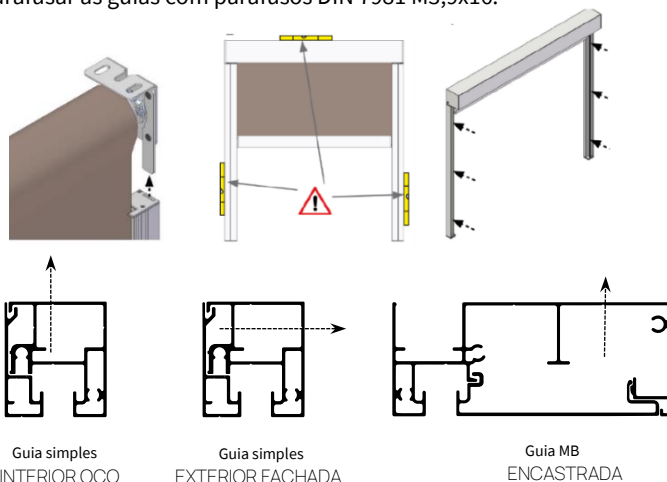

## REGULAÇÃO DO TOLDO

Ajuste os fins de curso do motor se for necessário. Para o correto funcionamento do toldo, subir e descer completamente o tecido várias vezes para o posicionar adequadamente.

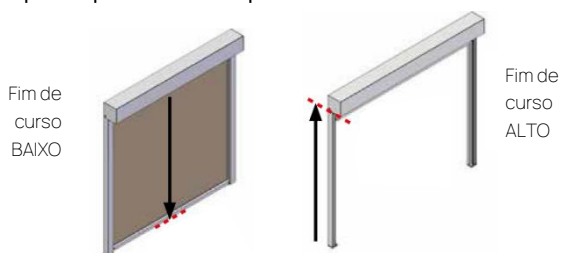

**A lona, uma vez estendida, pode apresentar rugas ou marcas por ter estado enrolada durante muito tempo. Isto NÃO é um problema, visto que estas marcas desaparecerão com o tempo devido às condições ambientais exteriores ao estabilizarem-se.**



## AURA / ÁGORA CABO

### INSTALAÇÃO DA CAIXA

Colocar os cabeçotes na respetiva posição e fixar consoante a montagem:

- (A) Instalação em interior oco
- (B) Instalação no exterior fachada.

### INSTALAÇÃO DA CAIXA COM SUPORTES

Opcionalmente, a caixa pode ser segura por meio de suportes. Para fazer isso, devem ser colocados e fixos, garantindo que ficam nivelados.

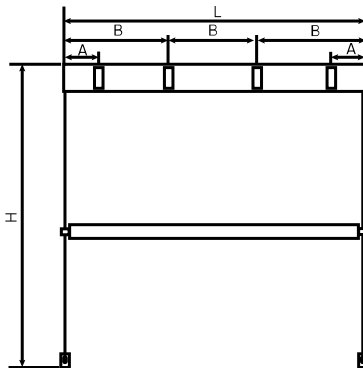
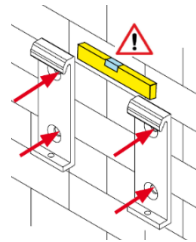

(ESQUEMA DE INSTALAÇÃO)

L	A	B
0-1500 (suportes) 2	150	B
1501-3000	3	150
3001-4000	4	150
4001-5000	5	150

### SISTEMAS DE FIXAÇÃO RECOMENDADOS

HSL-3-SK		BETÃO
Hilti HRD-U10 Hilti HRD-S10		BETÃO TIJOLO PERFURADO
HUD-1 HUD-L		TIJOLO MACIÇO

*Em ambientes corrosivos, é recomendável usar fixações de aço inoxidável*

\*Ver sequência do sistema de fixação na pág. 7

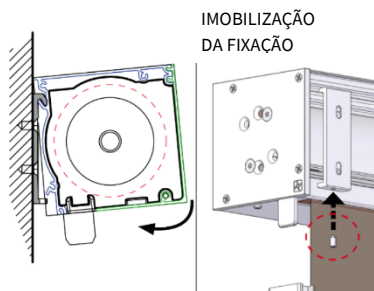
**Fixação à parede:**

coloque a caixa na respectiva posição e fixe-a pela parte posterior.

**Fixação no teto:** retire a tampa para aceder ao suporte. Coloque a caixa sobre as abas do suporte e fixe-o aparafusando o parafuso sem cabeça do suporte sobre o perfil.

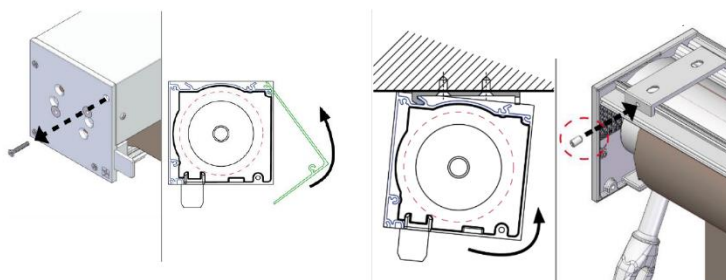
**FIXAÇÃO DO CABO**

Colocar o cabo seguindo o esquema seguinte. Fixar ao cabeçote, ao terminal e au suporte.

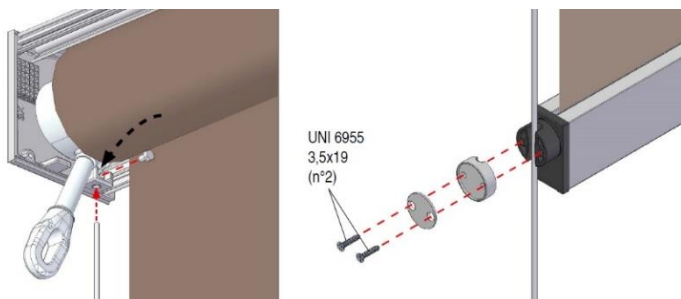

INSTALAÇÃO  
NO EXTERIOR  
DA FACHADA

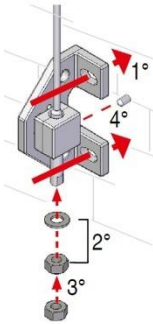

INSTALAÇÃO  
EM INTERIOR  
OOO

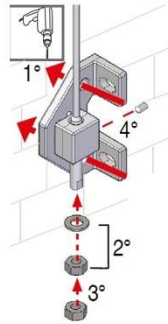

INSTALAÇÃO NO PAVIMENTO

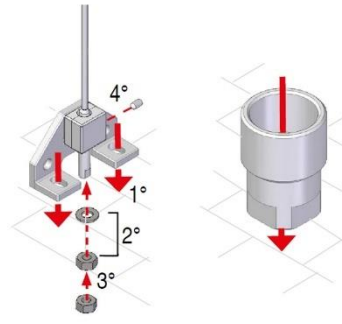

## REGULAÇÃO DO TOLDO

Ajuste os fins de curso do motor se for necessário. Para o correto funcionamento do toldo, subir e descer completamente o tecido várias vezes para o posicionar adequadamente.

Fim de  
curso  
BAIXO

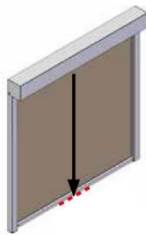

Fim de  
curso  
ALTO



**A lona, uma vez estendida, pode apresentar rugas ou marcas por ter estado enrolada durante muito tempo. Isto NÃO é um problema, visto que estas marcas desaparecerão com o tempo devido às condições ambientais exteriores ao estabilizarem-se.**

## NUVOLA CABO

### INSTALAÇÃO DOS CABEÇOTES

Una os pernos aos cabeçotes e coloque-os na posição. Introduza as guias interiores até ficarem niveladas. Fixar consoante a montagem:

- (C) Instalação em interior oco.
- (D) Instalação no exterior fachada.

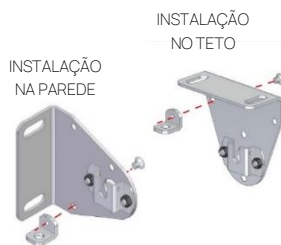

### SISTEMAS DE FIXAÇÃO RECOMENDADOS

HSL-3-SK		BETÃO
Hilti HRD-U10 Hilti HRD-S10		BETÃO TIJOLO PERFURADO TIJOLO MACIÇO
HUD-1 HUD-L		

*Em ambientes corrosivos, é recomendável usar fixações de aço inoxidável*

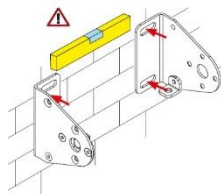

Ver sequência do sistema de fixação na pág. 7

Introduzir o cilindro com a junta no lado livre do eixo.

Colocar o eixo nos cabeçotes. Introduzir os pernos na cabeça do motor e no lado livre para fixá-lo.

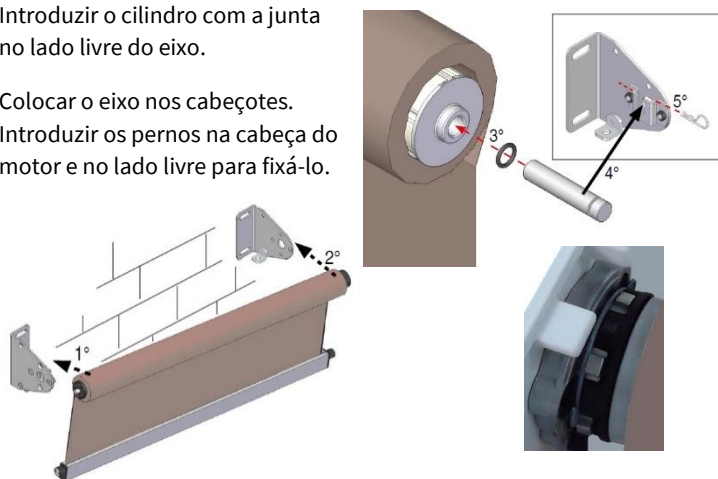

## FIXAÇÃO DO CABO

Colocar o cabo seguindo o esquema seguinte. Fixar ao cabeçote, ao terminal e ao suporte.

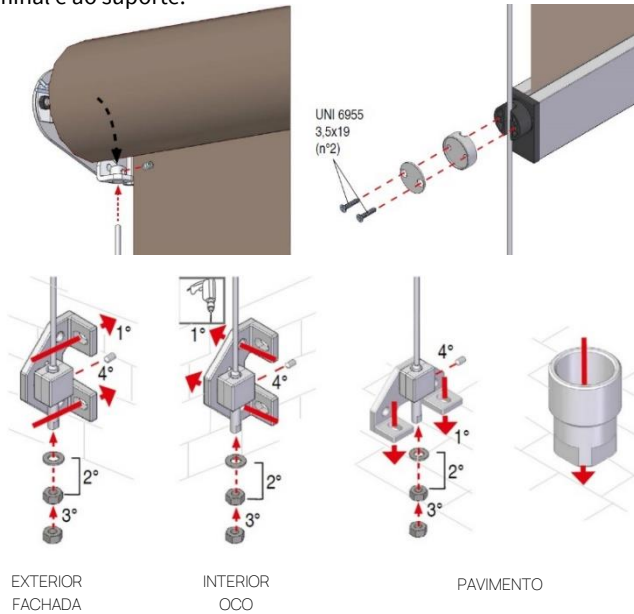

## REGULAÇÃO DO TOLDO

Ajuste os fins de curso do motor se for necessário. Para o correto funcionamento do toldo, subir e descer completamente o tecido várias vezes para o posicionar adequadamente.

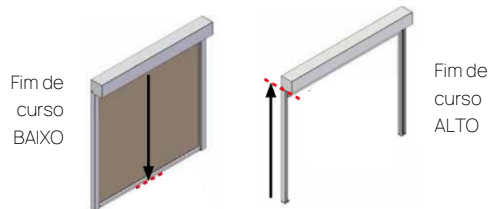

**A lona, uma vez estendida, pode apresentar rugas ou marcas por ter estado enrolada durante muito tempo. Isto NÃO é um problema, visto que estas marcas desaparecerão com o tempo devido às condições ambientais exteriores ao estabilizarem-se.**

## AURA / ÁGORA

## VARETA

## INSTALAÇÃO DA CAIXA

Colocar os cabecotes na respectiva posição e fixar consoante a montagem:

- (C) Instalação em interior oco.
- (D) Instalação no exterior fachada.

## INSTALAÇÃO DA CAIXA COM SUPORTES

Opcionalmente, a caixa pode ser segura por meio de suportes. Para fazer isso, devem ser colocados e fixos, garantindo que ficam nivelados.

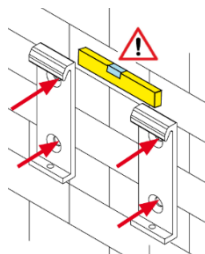

(ESQUEMA DE INSTALAÇÃO)

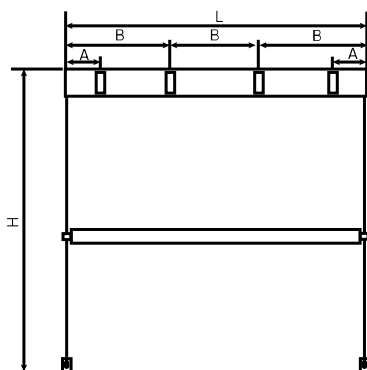

L	A	B
0-1500 L suportes	2	B
1501-3000 0-1500	3	L/2
3001-4000	4	L/3
4001-5000 3001-4000	5	L/4
4001-5000	5	L/4

## SISTEMAS DE FIXAÇÃO RECOMENDADOS

HSL-3-SK		BETÃO
Hilti HRD-U10 Hilti HRD-S10		BETÃO TIJOLO PERFURADO
HUD-1 HUD-L		TIJOLO MACIÇO

Em ambientes corrosivos, é recomendável usar fixações de aço inoxidável

\*Ver sequência do sistema de fixação na pág. 7

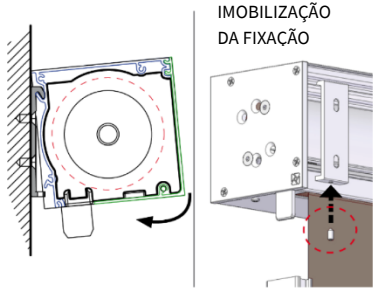

IMOBILIZAÇÃO  
DA FIXAÇÃO

**Fixação à parede:** coloque a caixa na respetiva posição e fixe-a pela parte posterior.

**Fixação no teto:** retire a tampa para aceder ao suporte. Coloque a caixa sobre as abas do suporte e fixe-o aparafusando o parafuso sem cabeça do suporte sobre o perfil.

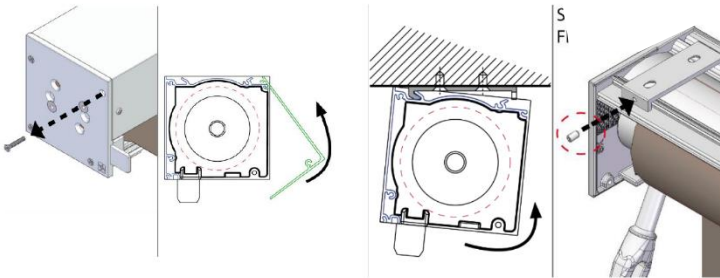

## FIXAÇÃO DA VARETA

Colocar a vareta seguindo o esquema seguinte. Fixar ao cabeçote, ao terminal e ao suporte.

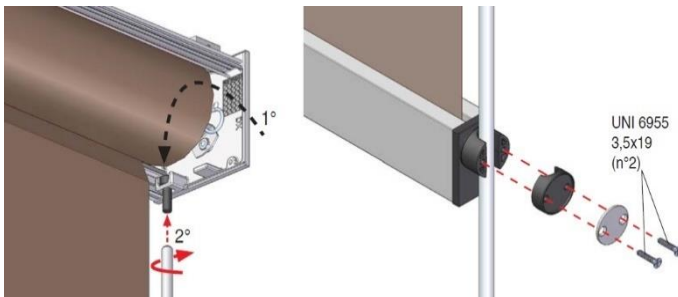

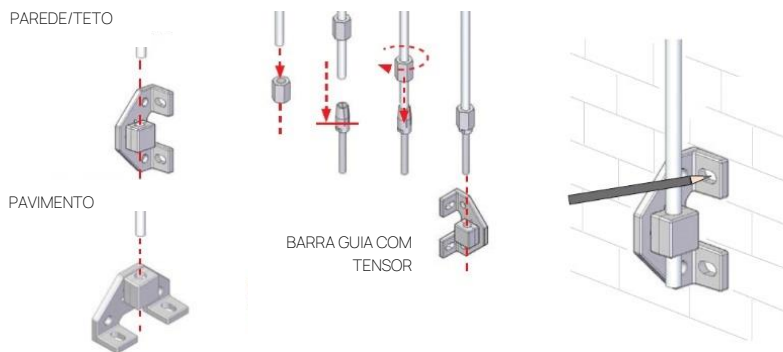

### REGULAÇÃO DO TOLDO

Ajuste os fins de curso do motor se for necessário. Para o correto funcionamento do toldo, subir e descer completamente o tecido várias vezes para o posicionar adequadamente.

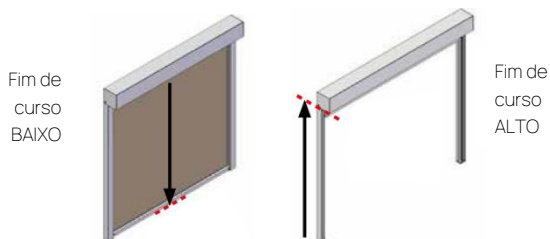

**A lona, uma vez estendida, pode apresentar rugas ou marcas por ter estado enrolada durante muito tempo. Isto NÃO é um problema, visto que estas marcas desaparecerão com o tempo devido às condições ambientais exteriores ao estabilizarem-se.**



## NUVOLA VARETA

### INSTALAÇÃO DOS CABEÇOTES

Una os pernos aos cabeçotes e coloque-os na posição. Introduza as guias interiores até ficarem niveladas. Fixar consoante a montagem:

- (C) Instalação em interior oco.
- (D) Instalação no exterior fachada.

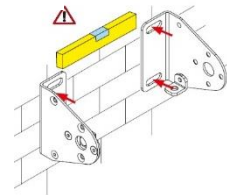

SISTEMAS DE FIJACIÓN RECOMENDADOS	
HSL-3-SK	BETÃO
Hilti HRD-U10 Hilti HRD-S10	BETÃO TIJOLO PERFURADO
HUD-1 HUD-L	TIJOLO MACIÇO

*Em ambientes corrosivos, é recomendável usar fixações de aço inoxidável*

\* Ver sequência do sistema de fixação na pág. 7

Introduzir o cilindro com a junta no lado livre do eixo.

Colocar o eixo nos cabeçotes. Introduzir os pernos na cabeça do motor e no lado livre para fixá-lo.

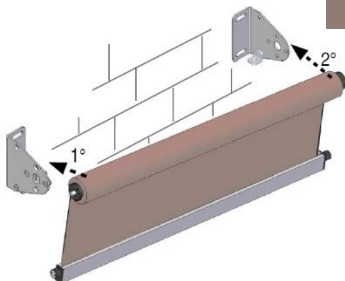
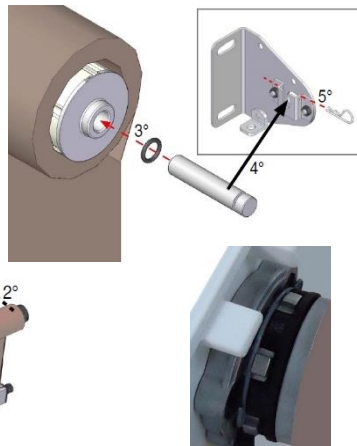

## FIXAÇÃO DA VARETA

Colocar a vareta seguindo o esquema seguinte. Fixar ao cabeçote, ao terminal e ao suporte.

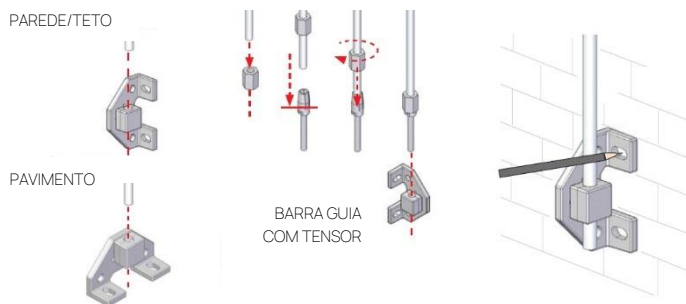
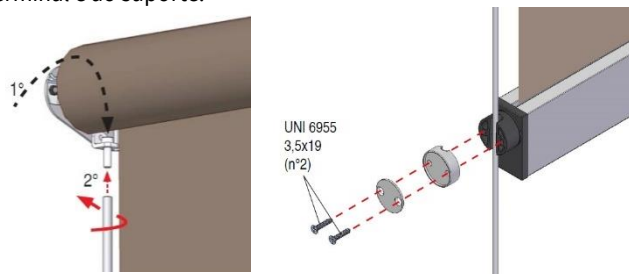

## REGULAÇÃO DO TOLDO

Ajuste os fins de curso do motor se for necessário. Para o correto funcionamento do toldo, subir e descer completamente o tecido várias vezes para o posicionar adequadamente.

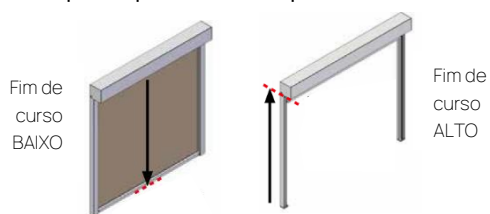

**Extendida la lona, esta puede presentar arrugas o marcas al haber estado enrollada durante largo tiempo. Esto NO representa un problema ya que estas marcas, por las condiciones ambientales exteriores, desaparecerán con el tiempo al estabilizarse.**

## MOTOR

### INSTALAÇÃO

A instalação do motor Senso RX da Cherubini deverá ser feita por um profissional da motorização e da automatização da habitação, a quem este guia se destina.

O instalador deverá, além disso, cumprir as regulações e a legislação em vigor no país de instalação e deverá informar os clientes sobre as condições de utilização e manutenção do produto. Qualquer uso diferente da aplicação estabelecida pela Cherubini será considerado um uso inadequado. Isto, juntamente com qualquer incumprimento das instruções que figuram nesta guia, implicará a exclusão da responsabilidade e da garantia por parte da Cherubini.

### LIGAÇÃO ELÉTRICA

A fim de evitar o mau funcionamento ou situações de perigo, os elementos eléctricos de comando ligados ao motor têm de ser dimensionados de acordo com as características eléctricas do próprio motor.

- A desconexão de um dispositivo deve estar prevista na rede eléctrica de acordo com as regras de instalação nacionais.
- Em caso de utilização no exterior, usar um cabo de alimentação com designação H05RN-F com um teor de carbono de pelo menos 2 %.
- Se o cabo branco não for usado, deverá ser sempre isolado. É perigoso tocar no cabo branco quando o motor estiver ligado à corrente.
- A instalação do botão é opcional, ligando-se indistintamente a Fase (cabo castanho) ou a Neutro (cabo azul). Com o botão, o motor irá funcionar em modalidade de passo a passo (subida, *stop*, descida, *stop*...)

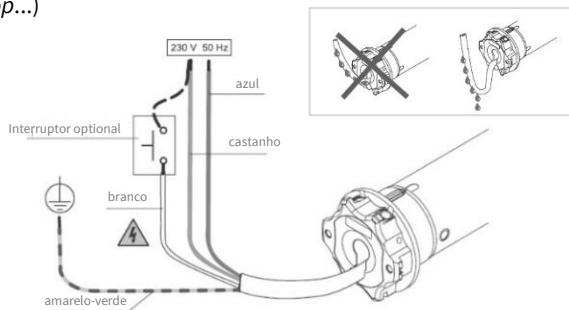

## ENTRADA EM FUNCIONAMENTO

### (I) Abertura da programação do emissor

Para evitar modificações acidentais na programação do motor durante o uso, a possibilidade de fazer programações é automaticamente desabilitada decorridas 8 horas da última sequência.

- ABERTURA / FECHO EM EMISSORES POP PLUS / POP LUX / POP PLUX / SKIPPER PLUS / SKIPPER LUX / SKIPPER PLUX

- Verifique o estado da função:

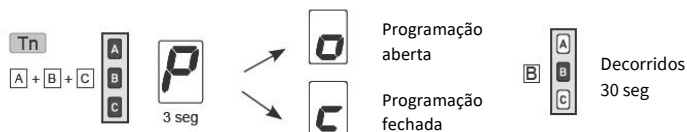

- Habilitar a programação:

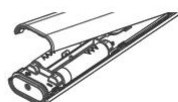

Quitar y poner las pilas

- Desabilitar a programação:



- **ABERTURA / FECHO EM EMISSORES SKIPPER / SÉRIE GIRO / EMISSOR POP**
  - Verificar o estado da função

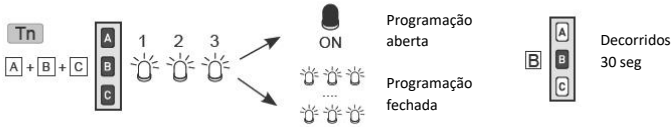

- Habilitar a programação

OPCIÓN 1



OPCIÓN 2

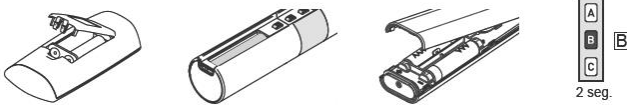

- Desabilitar a programação



- **MEMORIZAÇÃO DO PRIMEIRO EMISSOR**

Esta operação realiza-se quando o motor é novo ou quando se faz o cancelamento total da memória do motor. Durante esta fase, para evitar interferências, alimente um único motor.

Deve-se carregar nas teclas tal como se indica na sequência, sem passar mais de 4 segundos de um passo a outro. Se não for assim, a ordem não é aceite e terá de se repetir.

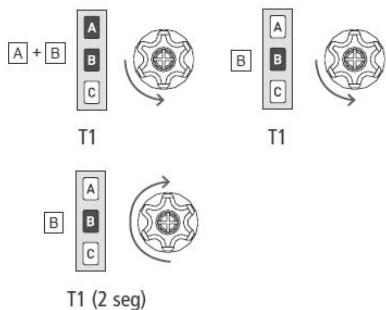

- Carregar simultaneamente em A+B Depois, carregar em B. Em ambos os casos, ao terminar, o motor realiza uma breve rotação num sentido.
- Carregar em B durante 2 seg. Para validar, o motor realiza uma rotação longa no sentido contrário

A seguir, dois exemplos de sequências incompletas:

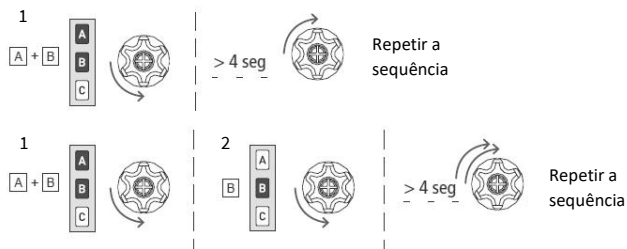

Cada vez que se dá corrente ao motor, dispõe-se de três horas para a memorização do primeiro emissor. Decorrido esse tempo, a opção de memorizar o primeiro emissor fica desabilitada. Para restabelecer o tempo da função, retirar e dar corrente.

▪ MEMORIZACIÓN DE OTROS EMISORES

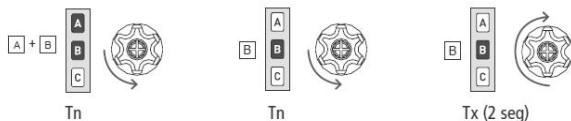

Tn: Emissor já memorizado

Tx: Emissor a memorizar

## ■ CANCELAMENTO DE UM EMISSOR

É possível cancelar individualmente todos os emissores memorizados. Após o cancelamento do último, o motor volta às condições iniciais.

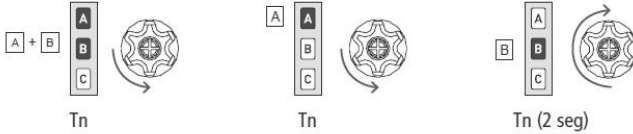

*Tn: Emissor já memorizado*

## ■ CANCELAMENTO TOTAL DE EMISSORES

- Desde o emissor:

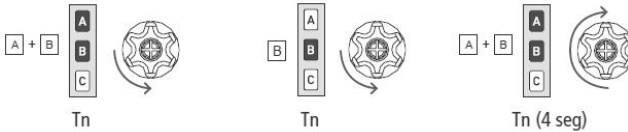

*Tn: Emissor já memorizado*

- Desde o cabo auxiliar (utilizar em caso de emergência):

1. Desligar a corrente através do automático
2. Juntar o cabo branco ao castanho (fase) ou azul (neutro)
3. Alimentar o motor
4. Voltar a desligar o motor da corrente (4 segundos)
5. Voltar a alimentar o motor. Após 4 seg, o motor realiza uma breve rotação, e uma rotação mais prolongada no sentido contrário
6. Desligar o motor da corrente
7. Separar o cabo branco do castanho/azul. Isolar devidamente o cabo antes de ligar a corrente

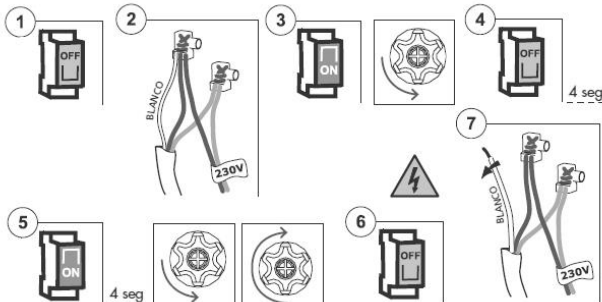

**(II) Ajustamentos fim de curso**

- **REGULAÇÃO DO FIM DE CURSO DE FECHO**

- Recolher o toldo até à posição de fecho.
- Fixar enquanto se carrega em «STOP» até o motor realizar uma rotação em descida.

Se o toldo estiver completamente fechado:

- Descer uns 20 cm. É possível que seja necessário usar a tecla de subida, porque o sentido correto de rotação será identificado só depois de se ter memorizado a posição de fecho.
- Fixar a posição correta carregando em «STOP» até o motor realizar uma rotação em descida.

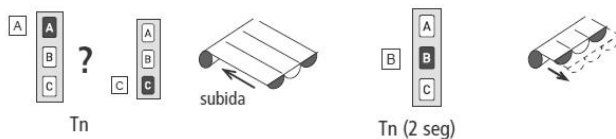

*Tn: Emissor já memorizado*

- **REGULAÇÃO DO FIM DE CURSO DE ABERTURA**

- Levar o toldo até à posição de abertura mantendo a tecla de descida do emissor.
- Fixar a posição enquanto se carrega em «STOP» durante 2 seg até o motor realizar uma rotação em subida.

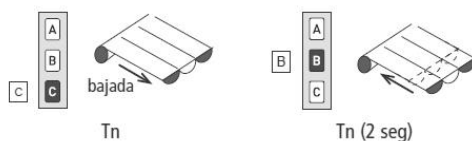

*Tn: Emissor já memorizado*



▪ **CANCELAMENTO DO FIM DE CURSO DE FECHO**

- Observar a sequência seguinte e proceder novamente à regulação do fim de curso de fecho e:

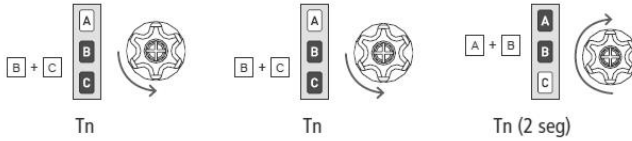

*Tn: Emissor já memorizado*

▪ **CANCELAMENTO DO FIM DE CURSO DE ABERTURA**

- Observar a sequência seguinte e proceder novamente à regulação do fim de curso de abertura:

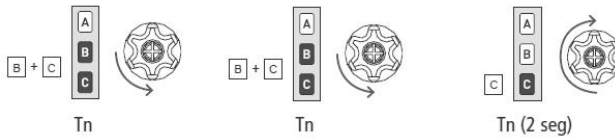

*Tn: Emissor já memorizado*

▪ **CANCELAMENTO TOTAL DOS FINS DE CURSO**

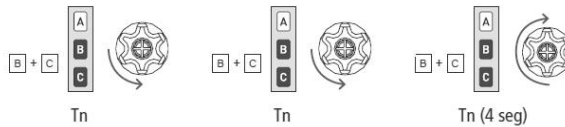

*Tn: Emissor já memorizado*

**(III) Funções avançadas**

▪ **POSIÇÃO INTERMÉDIA**

Memorização posição intermédia:

- Situar o toldo na posição preferida
- Carregar em «STOP» durante 4 seg até confirmação do motor
- Uma vez memorizada, para levar o toldo a esta posição, carregar em «STOP» durante 2 seg.

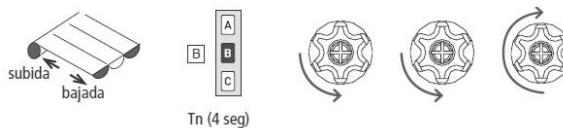

*Tn: Emissor já memorizado*

### Posição intermédia adicional:

- Posição útil para o toldo se abrir de forma automática através do sensor WindTec Lux.

Para regular a posição, primeiro memorizar os fins de curso e depois executar a sequência seguinte.

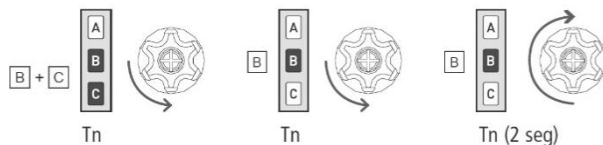

*Tn: Emissor já memorizado*

- Agora o motor está em “Homem presente” e permite executar esta posição com precisão.
- Mover o toldo até à posição de abertura desejada.
- Carregar em B durante 2 seg até o motor confirmar

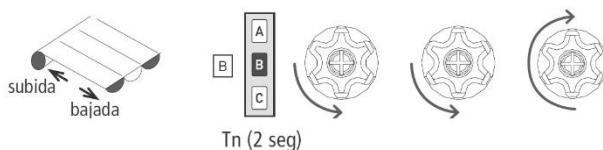

- Quando o WindTec Lux acionar a abertura com o automatismo luz, o toldo coloca-se na posição intermédia adicional.

### Cancelamento da posição intermédia:

- Realiza-se se não se desejar dispor desta função e para modificar a posição intermédia já memorizada.
- ANTES DE CANCELAR, levar o toldo à referida posição intermédia carregando em “STOP” durante 2 seg.
- Carregar em “STOP” durante 4 seg até o motor dar sinal de confirmação

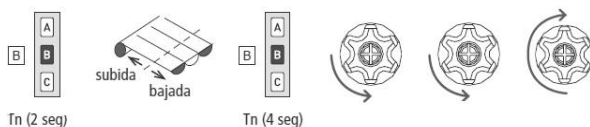

*Tn: Emissor já memorizado*

▪ **REGULAÇÃO DA FORÇA DE FECHO**

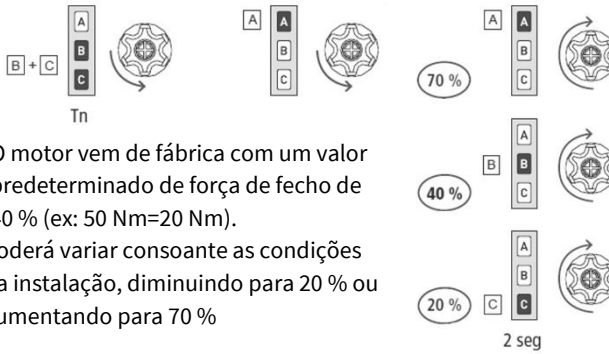

O motor vem de fábrica com um valor predeterminado de força de fecho de 40 % (ex: 50 Nm=20 Nm).

Poderá variar consoante as condições da instalação, diminuindo para 20 % ou aumentando para 70 %

▪ **POSIÇÃO TENSÃO LONA**

Ao habilitar esta função, quando se atinge a posição de abertura, o motor realiza um retrocesso automático da amplitude programada, que dá tensão à lona. Esta posição deve ser programada após memorizar os fins de curso.

- **INÍCIO DO PROCEDIMENTO DE MEMORIZAÇÃO DA POSIÇÃO OPCIONAL**

Esta sequência permite um ajustamento milimétrico da tensão, visto levar o toldo à máxima abertura e preparar o motor para o funcionamento “HOMEM PRESENTE”.

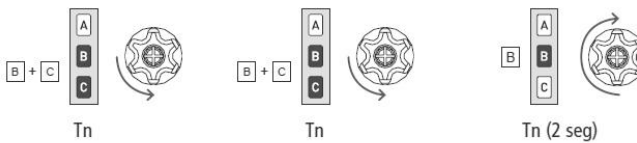

*T<sub>n</sub>: Emissor já memorizado*

▪ POSIÇÃO TENSÃO LONA

Ao habilitar esta função, quando se atinge a posição de abertura, o motor realiza um retrocesso automático da amplitude programada, que dá tensão à lona. Esta posição deve ser programada após memorizar os fins de curso.

- Início do procedimento de memorização da posição opcional:  
Esta sequência permite um ajustamento milimétrico da tensão, visto levar o toldo à máxima abertura e preparar o motor para o funcionamento HOMEM PRESENTE.

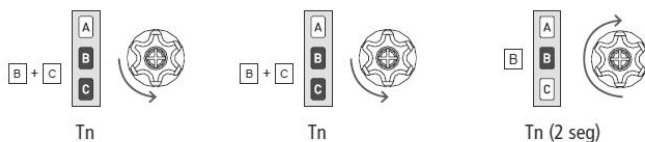

Tn: Emissor já memorizado

- Ajustamento e conformação da posição opcional:  
Após ajustar-se e confirmar-se a posição, o toldo realiza uma abertura até à posição máxima e regressa à nova posição.

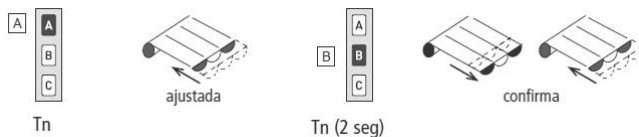

Tn: Emissor já memorizado

- Apagamento da posição opcional:

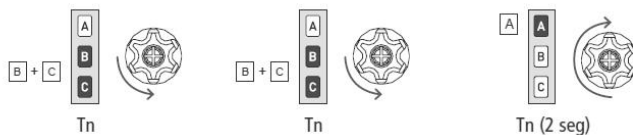

Tn: Emissor já memorizado

▪ **GESTÃO MODALIDADE DE COMANDO**

Há três configurações possíveis. Para passar de uma configuração a outra, repetir a sequência até chegar à configuração desejada. Estão disponíveis na ordem seguinte:

- Subida-*stop*-descida-*stop* (por predefinição).
- Subida-descida (para dois botões independentes).
- Subida-descida com “homem presente” (para dois botões independentes).

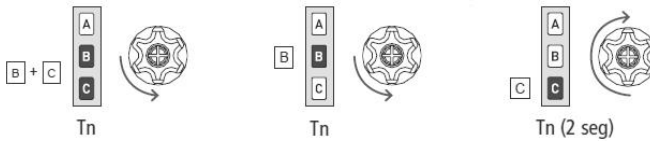

*Tn: Emissor já memorizado*

▪ **GESTÃO SUPER SENSIBILIDADE NA DETEÇÃO DE OBSTÁCULOS NA DESCIDA**

Se for necessário, pode-se ativar/desativar a sensibilidade muito elevada na detecção de obstáculos na descida.

- Ativar a função:

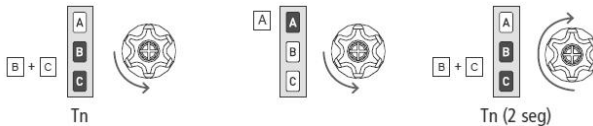

- Desativar a função:

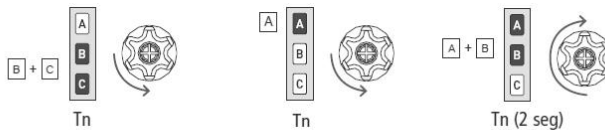

*Tn: Emissor memorizado*

## MANUTENÇÃO

Para um bom uso e uma maior durabilidade, recomenda-se a realização de manutenções e revisões periódicas, pelo menos uma vez por ano, ou com mais frequência em função da fadiga do vento no local de instalação. Para prevenir a corrosão recomenda-se a limpeza periódica de caleiras e perfis com sabão neutro. A frequência mínima é de uma vez por ano, devendo aumentar-se para os perfis expostos a ambientes agressivos (marítimos, industriais, presença de pó em suspensão, etc.). É importante lavar com água em abundância, após o uso de detergentes, para evitar a formação de sais sobre a superfície dos perfis. Esta limpeza periódica, adequadamente efetuada, elimina da superfície dos perfis os agentes exógenos que podem atacar o revestimento e o alumínio, prolongando a vida dos perfis e o seu desempenho estético. Para a limpeza da lona, recomenda-se a eliminação do pó acumulado a seco, para poder retirar todas as partículas da superfície por aspiração, insuflação de ar, batimento ou escovagem. Em caso de eliminação de manchas de dedos ou gordura usar água com sabão neutro. Se forem manchas aquosas, limpar no máximo com uma esponja e esfregar com um pano húmido. NUNCA utilizar detergentes nem outros produtos químicos. Por último, deve-se ter em conta a revisão do aperto de parafusos, conforme os binários de aperto.

As operações de instalação e entrada em funcionamento, de regulação e de manutenção obrigatória deverão ser efetuadas por técnicos especializados.

Todas as operações serão efetuadas em condições de segurança, depois de se ter cortado a alimentação elétrica do sistema.

É conveniente deslocar o produto periodicamente (extensão completa e recolha completa) e verificar se os componentes funcionam corretamente. Não deixar o produto parado durante muito tempo.

## LONA

A limpeza da lona é necessária para proteger a mesma da formação de bolor e atrasar a sujidade permanente. Por isso, recomendamos:

- Inspeccionar o seu estado pelo menos duas vezes por ano.
- Se for necessário, limpar com um aspirador e com uma esponja ou pano húmido, usando água morna e produtos não agressivos como sabão neutro.

Para a limpeza em condições de segurança, estenda o toldo, desligue a alimentação elétrica e limpe a parte do tecido à vista. Siga as instruções e em caso de dúvida entre em contacto com o seu distribuidor.

## DESMONTAGEM E ELIMINAÇÃO

A desmontagem do produto no fim da sua vida útil deverá ser efetuada por pessoal qualificado, com todas as características de segurança observadas na instalação.

Para desmontar este produto, os passos que se efetuaram para a montagem serão dados inversamente, adotando uma série de medidas de precaução. Para ampliar as informações sobre estas instruções de desmontagem, remetemo-lo para os capítulos deste manual sobre a instalação, que contêm desenhos e informações detalhadas.

Aconselhamos- que recicle a embalagem do produto de forma responsável:

- Classifique os desperdícios separando todos e cada um dos diversos materiais para proceder a uma efetiva eliminação da embalagem.
- Não elimine os materiais de embalagem juntamente com resíduos de outro tipo. Leve-os a um ponto de recolha de materiais de embalagem designado pelas autoridades locais.
- Tendo em vista reduzir ao mínimo o impacto ambiental das embalagens e resíduos de embalagens, é necessário definir a composição e natureza da embalagem dos nossos produtos para recomendar a melhor eliminação dos mesmos.

- **Papel e cartão:** Na gestão de resíduos, a reciclagem de papel e cartão adquire um grande protagonismo, dado que se consegue recuperar até 70 %. A eliminação de papel e cartão pode efetuar-se por diversas vias, tais como a recolha por operadores privados ou a entrega em instalações de tratamento de resíduos.
- **Plástico:** A reciclagem de plásticos representa muitas vantagens para o ambiente, portanto, vantagens na qualidade de vida de todos, contribuindo para uma grande poupança de matéria-prima, recursos naturais, energéticos e económicos. A eliminação do plástico pode efetuar-se através de operadores privados ou com a entrega em instalações de tratamento de resíduos.
- **Película alveolar:** É composto de polietileno de baixa densidade, o que o torna um material 100 % reciclável. Para a sua ótima eliminação, entregar os resíduos deste material em instalações de tratamento de resíduos plásticos.
- **Equipamentos elétricos, eletrónicos e equipamentos AEE:** não devem ser eliminados misturados com outro tipo de resíduos. Podem ser entregues nos centros específicos para tal, regulados pelas administrações locais.
- **Têxtil:** O aproveitamento dos resíduos têxteis é indispensável quando se trata de reciclar. A reutilização ajuda a reduzir o consumo de água e os gases que se libertam no processo de fabrico. Para favorecer a adequada eliminação dos têxteis, recomenda-se que se depositem num centro de resíduos especializado onde procederão à separação das diversas fibras têxteis.

Aja seguindo as recomendações para uma eficaz reciclagem dos produtos. Lembre-se de que reciclar é mais que uma ação, é o valor da responsabilidade em preservar os recursos naturais.



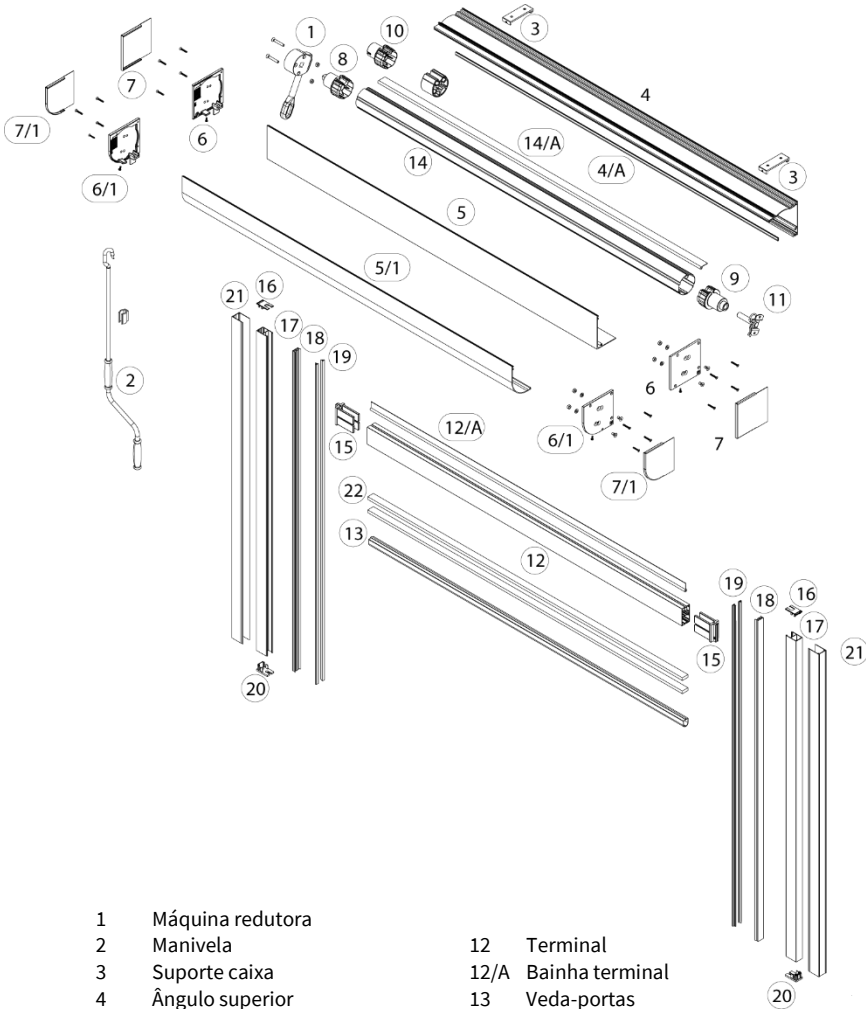

- |     |                            |      |                   |
|-----|----------------------------|------|-------------------|
| 1   | Máquina redutora           | 12   | Terminal          |
| 2   | Manivela                   | 12/A | Bainha terminal   |
| 3   | Suporte caixa              | 13   | Veda-portas       |
| 4   | Ângulo superior            | 14   | Eixo              |
| 5   | Tampa caixa Ágora          | 14/A | Bainha eixo       |
| 5/1 | Tampa caixa Aura           | 15   | Tampa terminal    |
| 6   | Cabeçote Ágora             | 16   | Funil para guia   |
| 6/1 | Cabeçote Aura              | 17   | Guia              |
| 7   | Embelezador cabeçote Ágora | 18   | Guia interior ZIP |
| 7/1 | Embelezador cabeçote Aura  | 19   | Guia exterior ZIP |
| 8   | Casquilho                  | 20   | Pé engate guia    |
| 9   | Casquilho oco              | 21   | Guia compensadora |
| 10  | Casquilho motor            | 22   | Chapa terminal    |
| 11  | H30 removable axle plate   |      |                   |

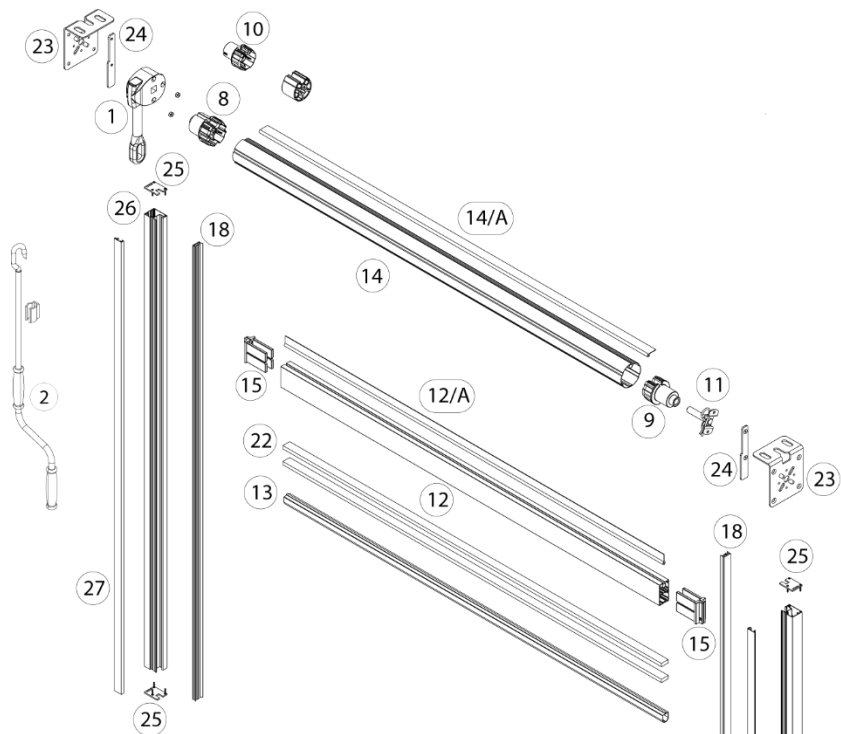

- |      |                         |    |                |
|------|-------------------------|----|----------------|
| 1    | Máquina redutora        | 24 | Perno          |
| 2    | Manivela                | 25 | Funil guia     |
| 8    | Casquilho               | 26 | Guia           |
| 9    | Casquilho oco           | 27 | Cobertura guia |
| 10   | Casquilho motor         |    |                |
| 11   | Placa H30 eixo amovível |    |                |
| 12   | Terminal                |    |                |
| 12/A | Bainha terminal         |    |                |
| 13   | Veda-portas             |    |                |
| 14   | Eixo                    |    |                |
| 14/A | Bainha eixo             |    |                |
| 15   | Tampa terminal          |    |                |
| 18   | Guia interior ZIP       |    |                |
| 22   | Chapa terminal          |    |                |
| 23   | Suporte Nuvola          |    |                |

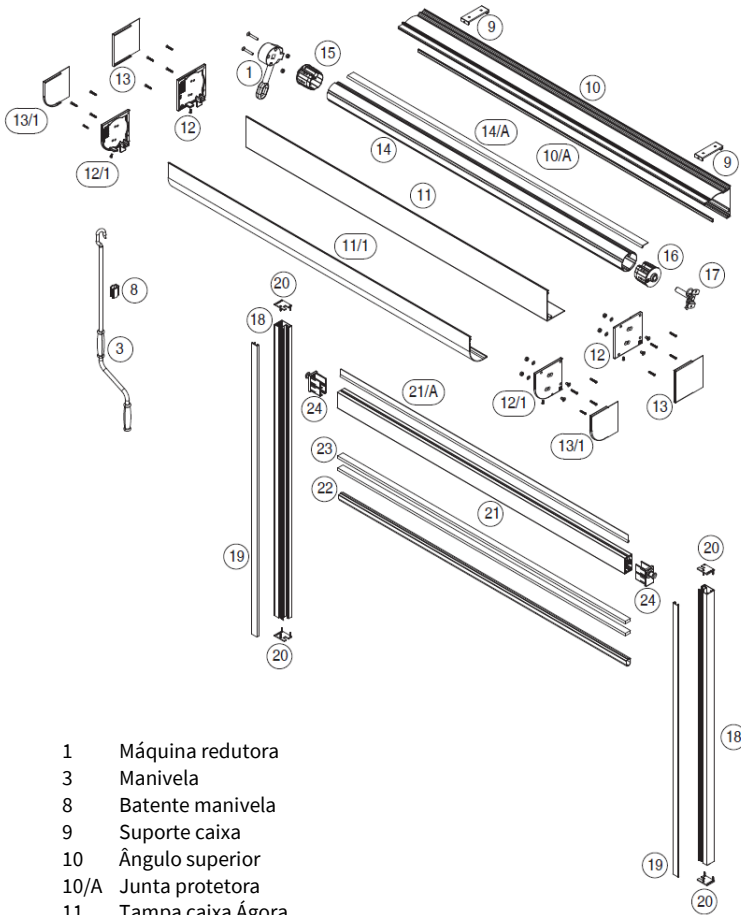

- |      |                            |      |                 |
|------|----------------------------|------|-----------------|
| 1    | Máquina redutora           | 18   | Guia            |
| 3    | Manivela                   | 19   | Cobertura guia  |
| 8    | Batente manivela           | 20   | Pé guia         |
| 9    | Suporte caixa              | 21   | Terminal        |
| 10   | Ângulo superior            | 21/A | Bainha terminal |
| 10/A | Junta protetora            | 22   | Veda-portas     |
| 11   | Tampa caixa Ágora          | 23   | Chapa           |
| 11/1 | Tampa caixa Aura           | 24   | Tampa terminal  |
| 12   | Cabeçote Ágora             |      |                 |
| 12/1 | Cabeçote Aura              |      |                 |
| 13   | Embelezador cabeçote Ágora |      |                 |
| 13/1 | Embelezador cabeçote Aura  |      |                 |
| 14   | Eixo                       |      |                 |
| 14/A | Bainha eixo                |      |                 |
| 15   | Casquilho com eixo 13x20   |      |                 |
| 16   | Casquilho vão Ø14          |      |                 |
| 17   | Placa H30 eixo amovível    |      |                 |

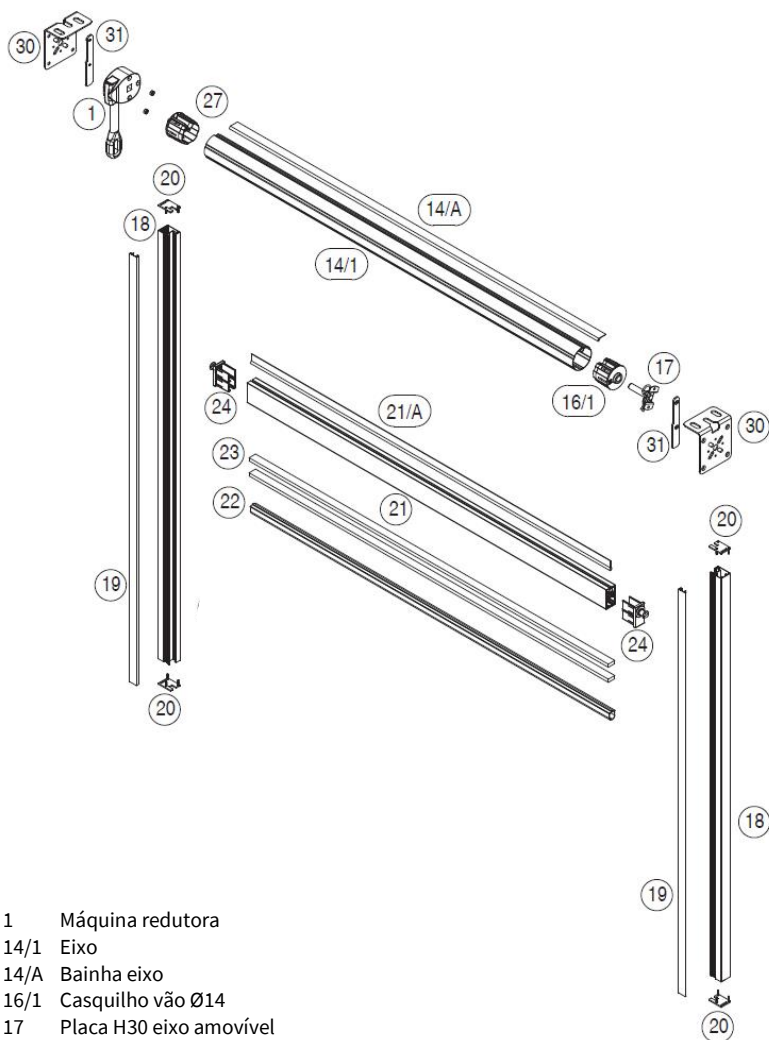

- 1 Máquina redutora
- 14/1 Eixo
- 14/A Bainha eixo
- 16/1 Casquilho vão Ø14
- 17 Placa H30 eixo amovível
- 18 Guia
- 19 Cobertura guia
- 20 Pé guia
- 21 Terminal
- 21/A Bainha terminal
- 22 Veda-portas
- 23 Chapa
- 24 Tapa terminal

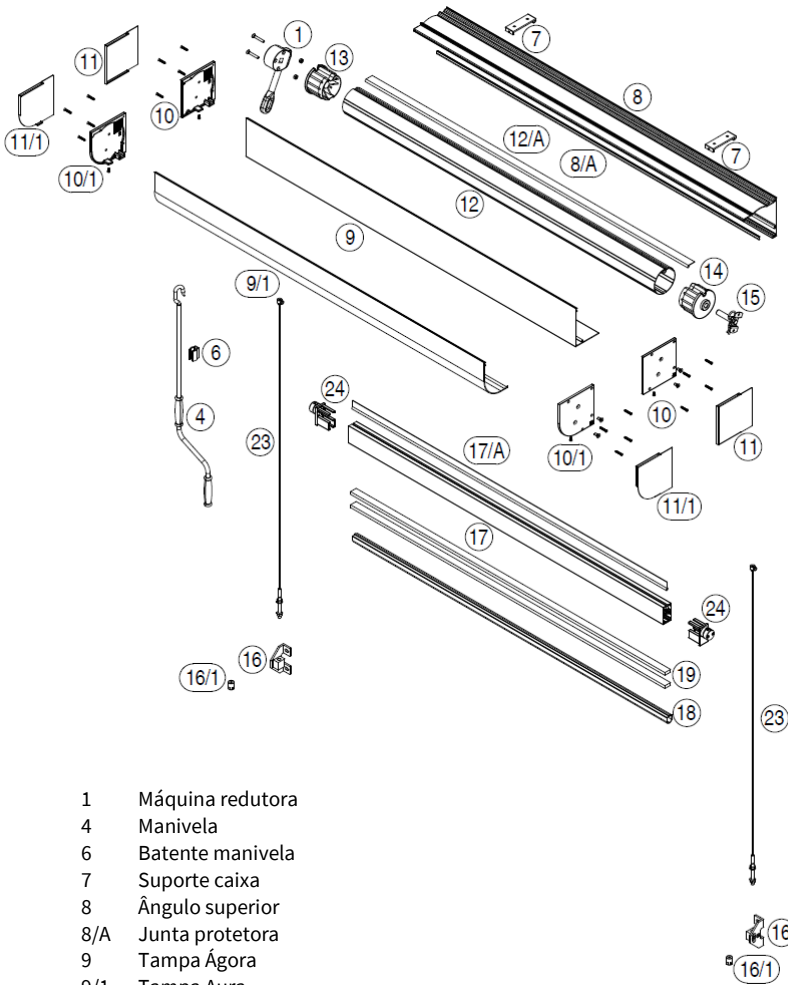

- |      |                            |      |                     |
|------|----------------------------|------|---------------------|
| 1    | Máquina redutora           | 16   | Suporte vareta/cabo |
| 4    | Manivela                   | 16/1 | Suporte cabo inox   |
| 6    | Batente manivela           | 17   | Terminal            |
| 7    | Suporte caixa              | 17/A | Bainha terminal     |
| 8    | Ângulo superior            | 18   | Veda-portas         |
| 8/A  | Junta protetora            | 19   | Chapa               |
| 9    | Tampa Ágora                | 23   | Cabo inox Ø4 mm     |
| 9/1  | Tampa Áura                 | 24   | Tampa terminal      |
| 10   | Cabeçote Ágora             |      |                     |
| 10/1 | Cabeçote Áura              |      |                     |
| 11   | Embelezador cabeçote Ágora |      |                     |
| 11/1 | Embelezador cabeçote Áura  |      |                     |
| 12   | Eixo                       |      |                     |
| 12/A | Bainha eixo                |      |                     |
| 13   | Casquilho com eixo 13x20   |      |                     |
| 14   | Casquilho vão Ø14          |      |                     |
| 15   | Placa H30 eixo amovível    |      |                     |

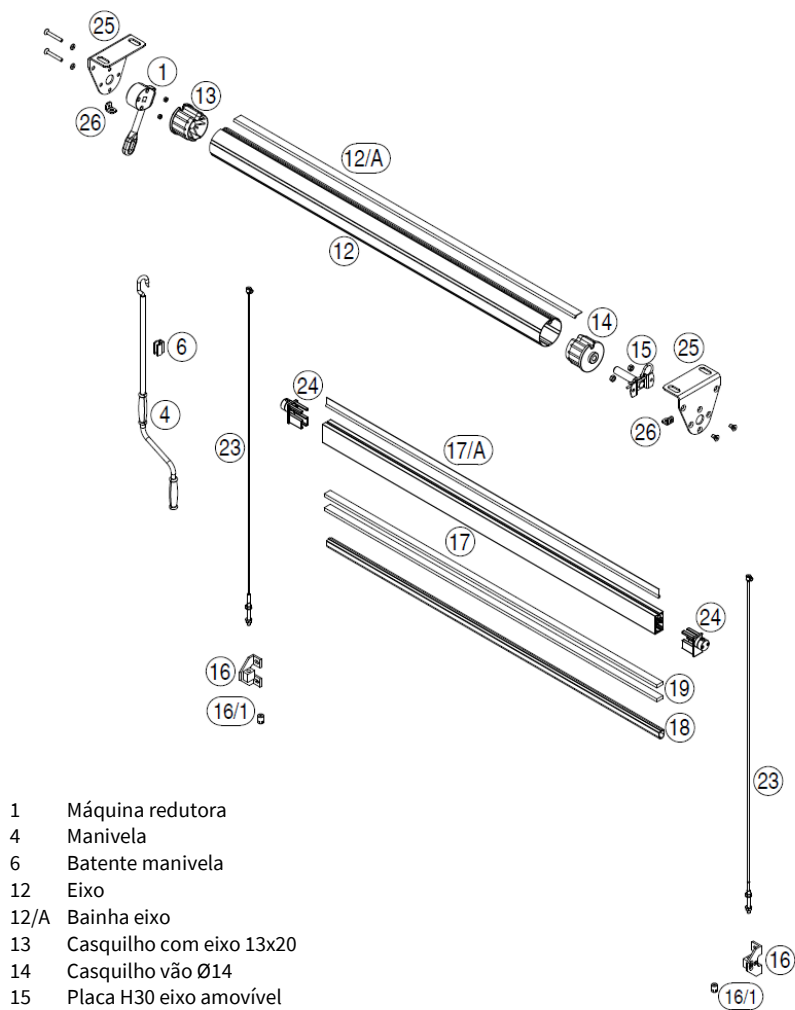

- 1 Máquina redutora
- 4 Manivela
- 6 Batente manivela
- 12 Eixo
- 12/A Bainha eixo
- 13 Casquilho com eixo 13x20
- 14 Casquilho vão Ø14
- 15 Placa H30 eixo amovível
- 16 Suporte vareta/cabo
- 16/1 Suporte cabo inox
- 17 Terminal
- 17/A Bainha terminal
- 18 Veda-portas
- 19 Chapa
- 23 Cabo inox Ø4 mm
- 24 Tapa terminal
- 25 Suporte Nuvola cabo/vareta
- 26 Suporte vareta/cabo

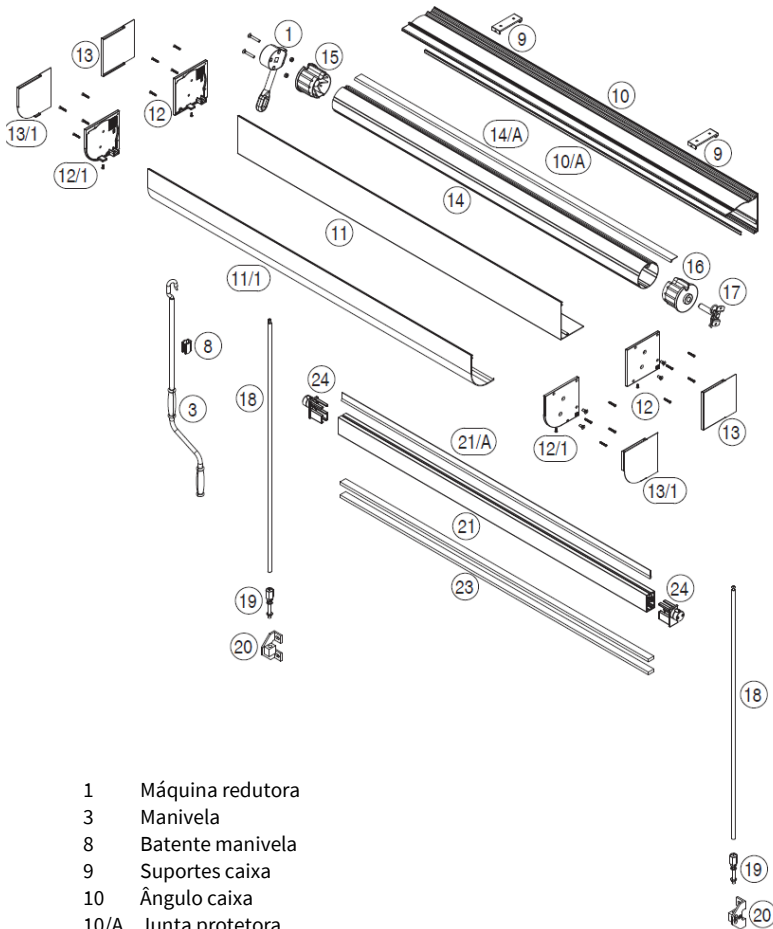

- |      |                            |      |                     |
|------|----------------------------|------|---------------------|
| 1    | Máquina redutora           | 18   | Vareta inox Ø10 mm  |
| 3    | Manivela                   | 19   | Tensor para vareta  |
| 8    | Batente manivela           | 20   | Suporte vareta/cabo |
| 9    | Suportes caixa             | 21   | Terminal            |
| 10   | Ângulo caixa               | 21/A | Bainha terminal     |
| 10/A | Junta protetora            | 23   | Chapa               |
| 11   | Tampa Ágora                | 24   | Tampa terminal      |
| 11/1 | Tampa Aura                 |      |                     |
| 12   | Cabeçote Ágora             |      |                     |
| 12/1 | Cabeçote Aura              |      |                     |
| 13   | Embelezador cabeçote Ágora |      |                     |
| 13/1 | Embelezador cabeçote Aura  |      |                     |
| 14   | Eixo                       |      |                     |
| 14/A | Bainha eixo                |      |                     |
| 15   | Casquilho com eixo 13x20   |      |                     |
| 16   | Casquilho vão Ø14          |      |                     |
| 17   | Placa H30 eixo amovível    |      |                     |

(R1)

NUVOLA VARETA



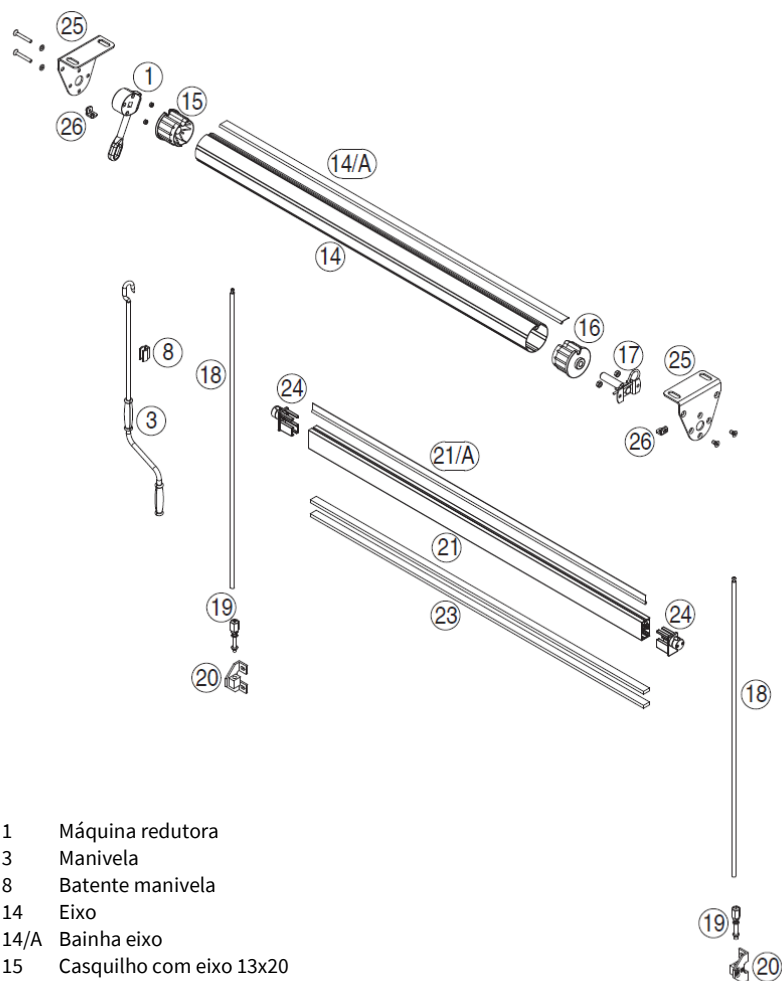















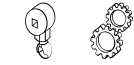
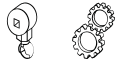

DIAGRAMA DE PEÇAS



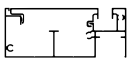
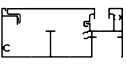

















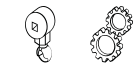
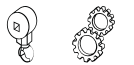



- 1 Máquina redutora
- 3 Manivela
- 8 Batente manivela
- 14 Eixo
- 14/A Bainha eixo
- 15 Casquilho com eixo 13x20
- 16 Casquilho vão Ø14
- 17 Placa H30 eixo amovível
- 18 Vareta inox Ø10 mm
- 19 Tensor vareta inox
- 20 Suporte vareta/cabo
- 21 Terminal
- 21/A Bainha terminal
- 23 Chapa
- 24 Tapa terminal
- 25 Suporte Nuvola
- 26 Suporte vareta/cabo

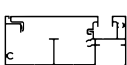
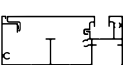

## ÁGORA

Tamanhos	110				130			
Sistema								
Automatismo								
Compatibilidade guias			-				-	
(Fixação)							-	
								
			-				-	
			-				-	
			-				-	

















## AURA

Tamanhos	110				130				150
Sistema									
Automatismo									
Compatibilidade guias			-				-		
(Fixação)									
									
			-				-		
			-				-		
			-				-		

COMBINAÇÕES

(R1)

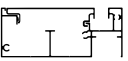
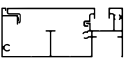
# NUVOLA

Tamanhos	110				130			
Sistema								
Automatismo								
Compatibilidad e guias			-				-	
(Fixação)								
								
								

											
---	---	---	---	---	---	---	---	---	---	---	---

COMBINAÇÕES

## PROBLEMAS, CAUSAS E SOLUÇÕES

PROBLEMAS	CAUSAS	SOLUÇÕES
O tecido desloca-se para um lado	Toldo mal nivelado	Nivelar corretamente
O terminal não desce	Proteção térmica do motor	Colocar as guias corretamente
O motor não funciona após vários minutos de funcionamento contínuo	Avaria do motor	Deixar arrefecer o motor durante alguns minutos
O motor é muito ruidoso	Avaria do motor	É necessário intervenção técnica
O motor não se mexe	Erro de cablagem	Verificar o circuito elétrico com os diagramas
	Avaria do motor	Verificar o motor e substituí-lo se for necessário





**Maure** Living the  
Outdoors

Pol. Ind. Río Vinalopó  
Apto. 7  
03630 Sax  
(Alicante - Spain)  
T +34 965 47 40 00 - 01  
[www.laviuda.es](http://www.laviuda.es) / [www.maure.es](http://www.maure.es)

Una marca de | **LaViuda**